

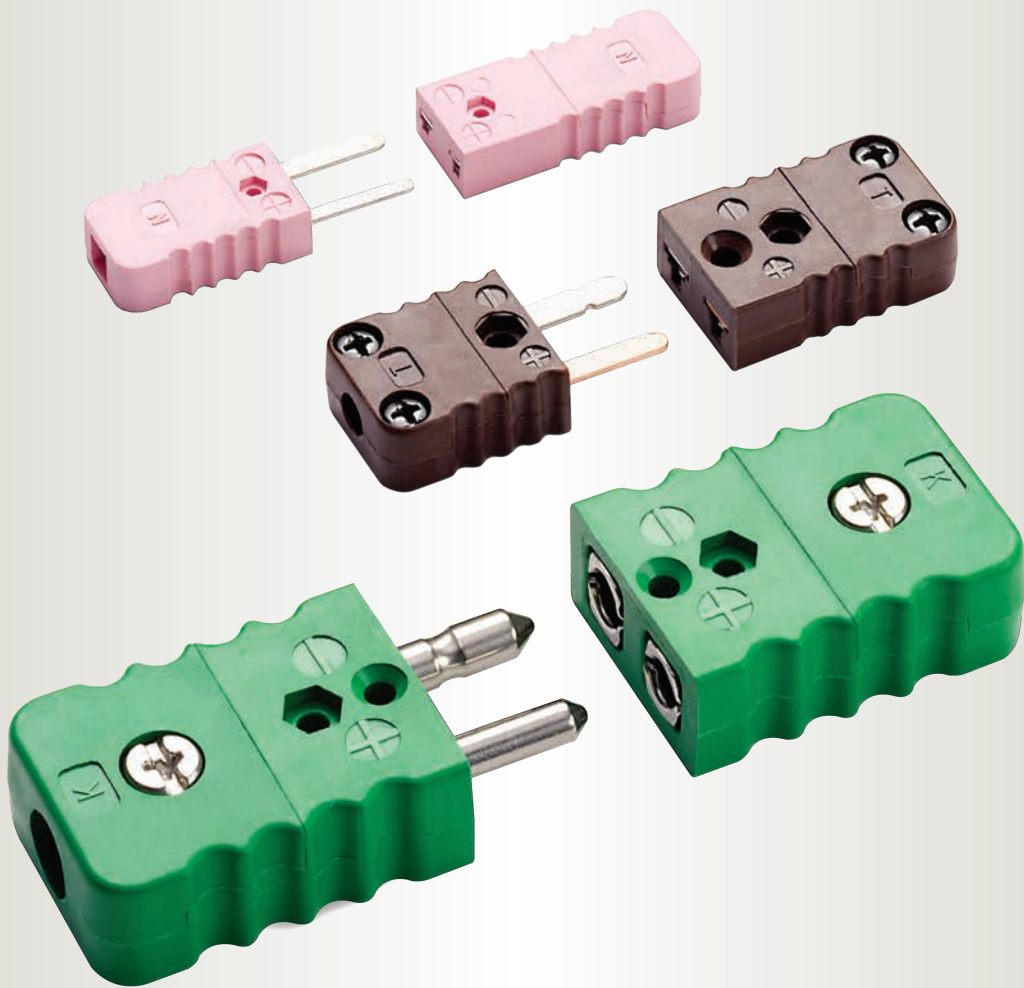

# Thermocouple and RTD Connectors

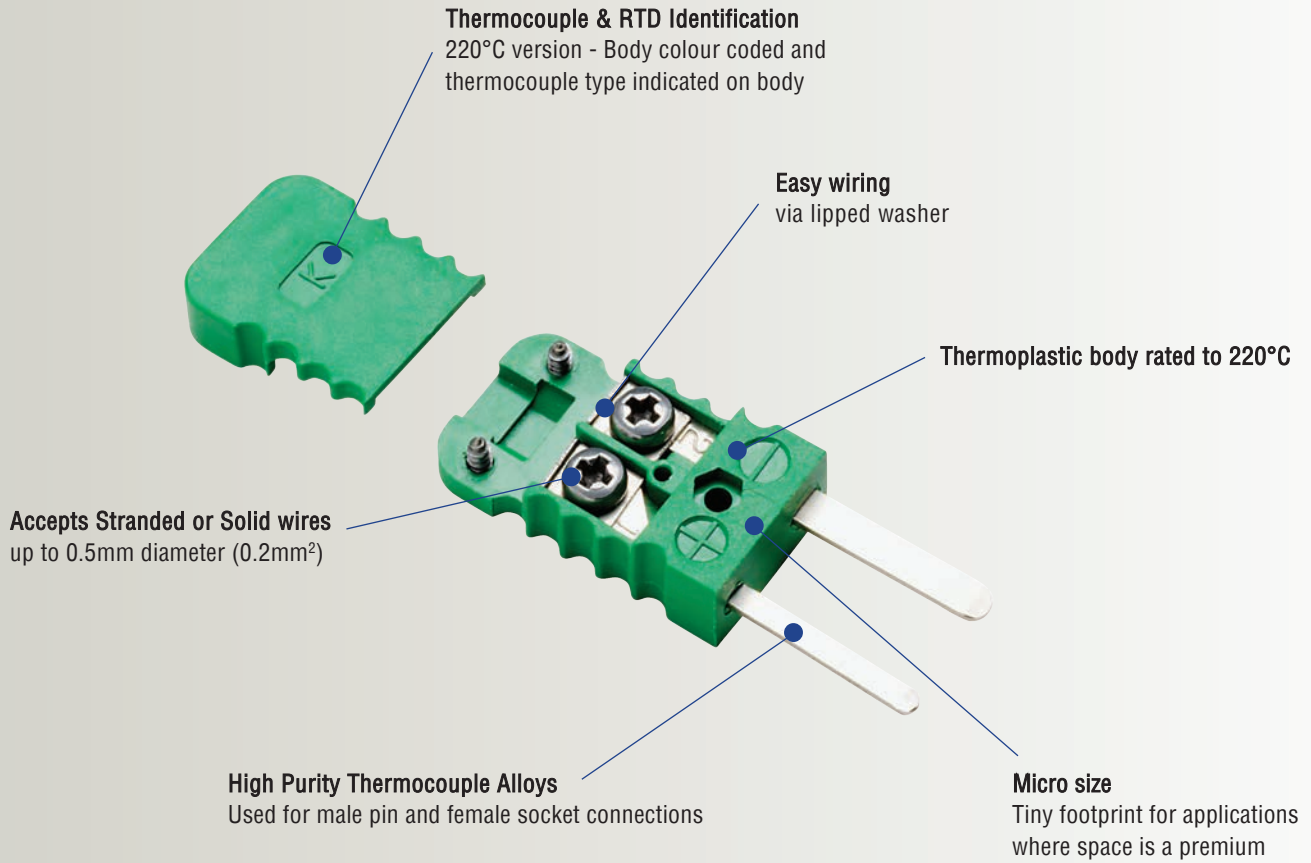

# Micro Thermocouple & RTD Connectors - Features



## Colours available: IEC, ANSI, DIN or JIS

Calibration Type	K	T	J	N	R/S	E	Cu*
<b>Conductors</b>	NiCr/ NiAl	Cu/ Con	Fe/ Con	NiCrSi/ NiSi	Cu/ Alloy 11	NiCr/ Con	Cu
<b>IEC 60584.3</b>							

Calibration Type	K	T	J	N	R/S	E	Cu*
<b>Conductors</b>	NiCr/ NiAl	Cu/ Con	Fe/ Con	NiCrSi/ NiSi	Cu/ Alloy 11	NiCr/ Con	Cu
<b>ANSI MC96.1</b>							

Calibration Type	K	T	U	J	L	R/S	E
<b>Conductors</b>	NiCr/ NiAl	Cu/ Con	Cu/ Con	Fe/ Con	Fe/ Con	Cu/ Alloy 11	NiCr/ Con
<b>DIN 43714</b>							

Calibration Type	K	T	J	N	R/S	E	Cu*
<b>Conductors</b>	NiCr/ NiAl	Cu/ Con	Fe/ Con	NiCrSi/ NiSi	Cu/ Alloy 11	NiCr/ Con	Cu
<b>JIS C 1610</b>							

\* Not an internationally recognised standard

# Micro Plugs rated to 220°C

## M11 Micro Plug

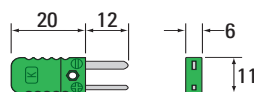

Type K IEC illustrated (M11K-I)

IEC Colours			ANSI Colours		
Part No.	Type	Colour	Part No.	Type	Colour
M11K-I	K	Green	M11K-A	K	Yellow
M11T-I	T	Brown	M11T-A	T	Blue
M11J-I	J	Black	M11J-A	J	Black
M11N-I	N	White	M11N-A	N	Orange
M11RS-I	R/S	Red	M11RS-A	R/S	Green
M11E-I	E	Purple	M11E-A	E	Purple
M11B-I	B	Grey	M11B-A	B	Grey
M11CU	Cu	White	M11CU	Cu	White

# Micro Sockets rated to 220°C

## M20 Micro Socket

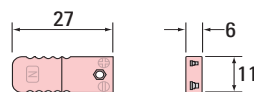

Type N IEC illustrated (M20N-I)

IEC Colours			ANSI Colours		
Part No.	Type	Colour	Part No.	Type	Colour
M20K-I	K	Green	M20K-A	K	Yellow
M20T-I	T	Brown	M20T-A	T	Blue
M20J-I	J	Black	M20J-A	J	Black
M20N-I	N	White	M20N-A	N	Orange
M20RS-I	R/S	Red	M20RS-A	R/S	Green
M20E-I	E	Purple	M20E-A	E	Purple
M20B-I	B	Grey	M20B-A	B	Grey
M20CU	Cu	White	M20CU	Cu	White

## M29 Micro Panel Socket - Rectangle Flanged with Bracket

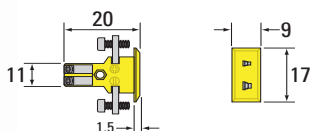

Type K ANSI illustrated (M29K-A). Recommended cutout: 6mm x 14mm

IEC Colours			ANSI Colours		
Part No.	Type	Colour	Part No.	Type	Colour
M29K-I	K	Green	M29K-A	K	Yellow
M29T-I	T	Brown	M29T-A	T	Blue
M29J-I	J	Black	M29J-A	J	Black
M29N-I	N	White	M29N-A	N	Orange
M29RS-I	R/S	Red	M29RS-A	R/S	Green
M29E-I	E	Purple	M29E-A	E	Purple
M29B-I	B	Grey	M29B-A	B	Grey
M29CU	Cu	White	M29CU	Cu	White

# Micro Connector Accessories and Panels

## Crimp Adaptors – For Micro Connectors

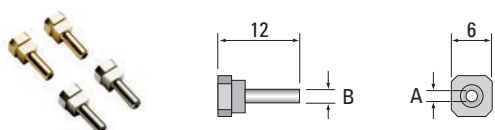

### Application

The adaptor can be crimped onto a mineral insulated cable or metal tube so it may then be attached to a micro connector (stainless steel versions may also be brazed). They can also be used to crimp some soft materials such as PVC or PFA wires or cables.

### Construction

Brass or Stainless Steel.

Sheath Diameter 'A'	Crimp Dimension 'B'	Part codes for use with 220°C rated micro connectors: M11 and M20	
		Plain Brass	Stainless Steel*
0.5mm	2.4mm	M8905B	M8005
1.0mm	2.4mm	M8910B	M8010
1.5mm	2.4mm	M8915B	M8015
1.6mm (1/16")	2.4mm	M8916B	M8016
2.0mm	3.2mm	M8920B	M8020
3.0mm	4.5mm	M8930B	M8030
3.2mm (1/8")	4.5mm	M8932B	M8032

\* Stainless steel inserts may be crimped or brazed to sheath

## Anodised Aluminium Panels – For Flanged Micro Connectors

For use with connector M29		MFP Panel without panel mounting holes	MFS Panel with panel mounting holes
		Panel thickness = 2mm	Panel thickness = 2mm
No. of Channels	Dimensions A x B in mm	MFP Aluminium Panel	MFS Aluminium Panel
1	22 x 36	MFP01	MFS01
2	35 x 36	MFP02	MFS02
4	61 x 36	MFP04	MFS04
6	87 x 36	MFP06	MFS06
8	113 x 36	MFP08	MFS08
10	139 x 36	MFP10	MFS10
12	165 x 36	MFP12	MFS12
16	113 x 60	MFP16	MFS16
20	139 x 60	MFP20	MFS20
24	165 x 60	MFP24	MFS24

All dimensions are in mm

# Miniature Thermocouple & RTD Connectors - Features

## Thermocouple & RTD Identification

- 220°C version - Body colour coded and thermocouple type indicated on body
- 350°C version - Thermocouple type indicated on body
- 650°C version - Colour dot on body

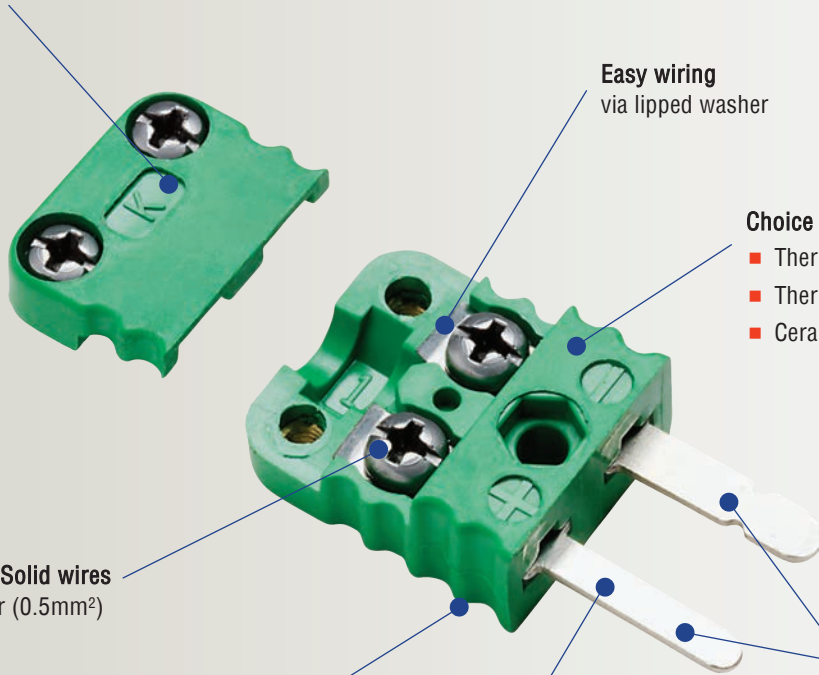

## Choice of body types:

- Thermoplastic rated to 220°C
- Thermosetting plastic rated to 350°C
- Ceramic rated to 650°C

Accepts Stranded or Solid wires up to 0.8mm diameter (0.5mm<sup>2</sup>)

Manufactured in accordance with standard EN 50212

High Purity Thermocouple Alloys  
Used for male pin and female socket connections

Polarised Flat Pins

## Colours available: IEC, ANSI, DIN or JIS

Calibration Type	K	T	J	N	R/S	E	Cu*
Conductors	NiCr/ NiAl	Cu/ Con	Fe/ Con	NiCrSi/ NiSi	Cu/ Alloy 11	NiCr/ Con	Cu
IEC 60584.3							

Calibration Type	K	T	J	N	R/S	E	Cu*
Conductors	NiCr/ NiAl	Cu/ Con	Fe/ Con	NiCrSi/ NiSi	Cu/ Alloy 11	NiCr/ Con	Cu
ANSI MC96.1							

Calibration Type	K	T	U	J	L	R/S	E
Conductors	NiCr/ NiAl	Cu/ Con	Cu/ Con	Fe/ Con	Fe/ Con	Cu/ Alloy 11	NiCr/ Con
DIN 43714							

Calibration Type	K	T	J	N	R/S	E	Cu*
Conductors	NiCr/ NiAl	Cu/ Con	Fe/ Con	NiCrSi/ NiSi	Cu/ Alloy 11	NiCr/ Con	Cu
JIS C 1610							

\* Not an internationally recognised standard

# Miniature Plugs rated to 220°C

## F11 Miniature Plug

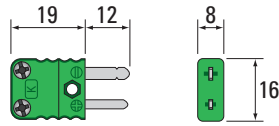

Type K IEC illustrated (F11K-I)

IEC Colours			ANSI Colours		
Part No.	Type	Colour	Part No.	Type	Colour
F11K-I	K	Green	F11K-A	K	Yellow
F11T-I	T	Brown	F11T-A	T	Blue
F11J-I	J	Black	F11J-A	J	Black
F11N-I	N	Pink	F11N-A	N	Orange
F11RS-I	R/S	Red	F11RS-A	R/S	Green
F11E-I	E	Purple	F11E-A	E	Purple
F11B-I	B	Grey	F11B-A	B	Grey
F11CU	Cu	White	F11CU	Cu	White

## F14 Miniature Plug - Quick Wire

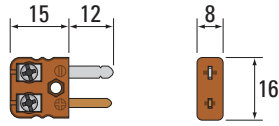

Type T IEC illustrated (F14T-I)

IEC Colours			ANSI Colours		
Part No.	Type	Colour	Part No.	Type	Colour
F14K-I	K	Green	F14K-A	K	Yellow
F14T-I	T	Brown	F14T-A	T	Blue
F14J-I	J	Black	F14J-A	J	Black
F14N-I	N	Pink	F14N-A	N	Orange
F14RS-I	R/S	Red	F14RS-A	R/S	Green
F14E-I	E	Purple	F14E-A	E	Purple
F14B-I	B	Grey	F14B-A	B	Grey
F14CU	Cu	White	F14CU	Cu	White

## F37 Miniature Panel Plug - Lugged

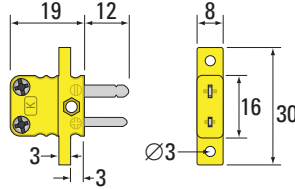

Type K ANSI illustrated (F37K-A). Recommended cutout: 8.5mm x 16.5mm

IEC Colours			ANSI Colours		
Part No.	Type	Colour	Part No.	Type	Colour
F37K-I	K	Green	F37K-A	K	Yellow
F37T-I	T	Brown	F37T-A	T	Blue
F37J-I	J	Black	F37J-A	J	Black
F37N-I	N	Pink	F37N-A	N	Orange
F37RS-I	R/S	Red	F37RS-A	R/S	Green
F37E-I	E	Purple	F37E-A	E	Purple
F37B-I	B	Grey	F37B-A	B	Grey
F37CU	Cu	White	F37CU	Cu	White

## F16 Miniature Plug - Three Pin

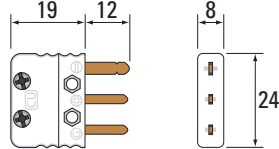
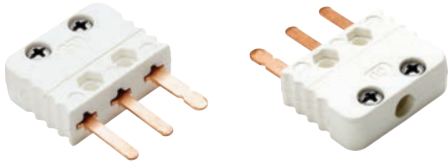

Type CU illustrated (F16CU)

IEC Colours			ANSI Colours		
Part No.	Type	Colour	Part No.	Type	Colour
F16K-I	K	Green	F16K-A	K	Yellow
F16T-I	T	Brown	F16T-A	T	Blue
F16J-I	J	Black	F16J-A	J	Black
F16N-I	N	Pink	F16N-A	N	Orange
F16RS-I	R/S	Red	F16RS-A	R/S	Green
F16E-I	E	Purple	F16E-A	E	Purple
F16B-I	B	Grey	F16B-A	B	Grey
F16CU	Cu	White	F16CU	Cu	White

## F91 Miniature Plug - Duplex

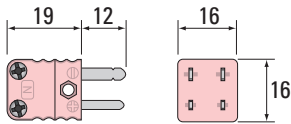

Type N IEC illustrated (F91N-I)

IEC Colours			ANSI Colours		
Part No.	Type	Colour	Part No.	Type	Colour
F91K-I	K	Green	F91K-A	K	Yellow
F91T-I	T	Brown	F91T-A	T	Blue
F91J-I	J	Black	F91J-A	J	Black
F91N-I	N	Pink	F91N-A	N	Orange
F91RS-I	R/S	Red	F91RS-A	R/S	Green
F91E-I	E	Purple	F91E-A	E	Purple
F91B-I	B	Grey	F91B-A	B	Grey
F91CU	Cu	White	F91CU	Cu	White

All dimensions are in mm

# Miniature Sockets rated to 220°C

## F20 Miniature Socket

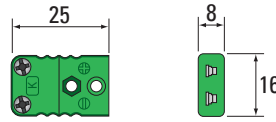

Type K IEC illustrated (F20K-I)

IEC Colours			ANSI Colours		
Part No.	Type	Colour	Part No.	Type	Colour
F20K-I	K	Green	F20K-A	K	Yellow
F20T-I	T	Brown	F20T-A	T	Blue
F20J-I	J	Black	F20J-A	J	Black
F20N-I	N	White	F20N-A	N	Orange
F20RS-I	R/S	Red	F20RS-A	R/S	Green
F20E-I	E	Purple	F20E-A	E	Purple
F20B-I	B	Grey	F20B-A	B	Grey
F20CU	Cu	White	F20CU	Cu	White

## F24 Miniature Socket - Quick Wire

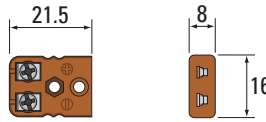

Type T IEC illustrated (F24T-I)

IEC Colours			ANSI Colours		
Part No.	Type	Colour	Part No.	Type	Colour
F24K-I	K	Green	F24K-A	K	Yellow
F24T-I	T	Brown	F24T-A	T	Blue
F24J-I	J	Black	F24J-A	J	Black
F24N-I	N	White	F24N-A	N	Orange
F24RS-I	R/S	Red	F24RS-A	R/S	Green
F24E-I	E	Purple	F24E-A	E	Purple
F24B-I	B	Grey	F24B-A	B	Grey
F24CU	Cu	White	F24CU	Cu	White

## F26 Miniature Panel Socket - Square Flanged with Bracket

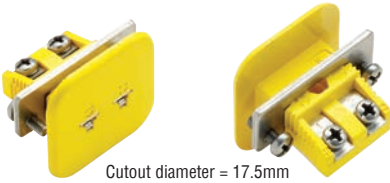

Cutout diameter = 17.5mm

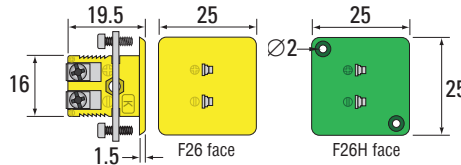

Type K ANSI illustrated (F26K-A). A version with two mounting holes is also available and is designated as part code F26H

IEC Colours			ANSI Colours		
Part No.	Type	Colour	Part No.	Type	Colour
F26K-I	K	Green	F26K-A	K	Yellow
F26T-I	T	Brown	F26T-A	T	Blue
F26J-I	J	Black	F26J-A	J	Black
F26N-I	N	White	F26N-A	N	Orange
F26RS-I	R/S	Red	F26RS-A	R/S	Green
F26E-I	E	Purple	F26E-A	E	Purple
F26B-I	B	Grey	F26B-A	B	Grey
F26CU	Cu	White	F26CU	Cu	White

## F29 Miniature Panel Socket - Rectangle Flanged with Bracket

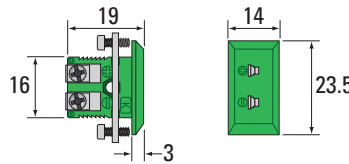

Type K IEC illustrated (F29K-I). Recommended cutout: 8mm x 16.5mm

IEC Colours			ANSI Colours		
Part No.	Type	Colour	Part No.	Type	Colour
F29K-I	K	Green	F29K-A	K	Yellow
F29T-I	T	Brown	F29T-A	T	Blue
F29J-I	J	Black	F29J-A	J	Black
F29N-I	N	White	F29N-A	N	Orange
F29RS-I	R/S	Red	F29RS-A	R/S	Green
F29E-I	E	Purple	F29E-A	E	Purple
F29B-I	B	Grey	F29B-A	B	Grey
F29CU	Cu	White	F29CU	Cu	White

## F29S Miniature Panel Socket - Rectangle Flanged with Spring Clip

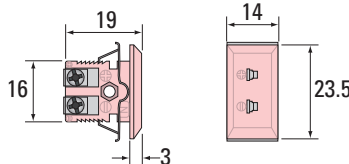
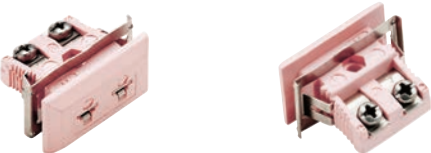

Type N IEC illustrated (F29SN-I). Recommended cutout: 8mm x 16.5mm

IEC Colours			ANSI Colours		
Part No.	Type	Colour	Part No.	Type	Colour
F29SK-I	K	Green	F29SK-A	K	Yellow
F29ST-I	T	Brown	F29ST-A	T	Blue
F29SJ-I	J	Black	F29SJ-A	J	Black
F29SN-I	N	White	F29SN-A	N	Orange
F29SRS-I	R/S	Red	F29SRS-A	R/S	Green
F29SE-I	E	Purple	F29SE-A	E	Purple
F29SB-I	B	Grey	F29SB-A	B	Grey
F29SCU	Cu	White	F29SCU	Cu	White

## F27 Miniature Panel Socket - Lugged - Open Back

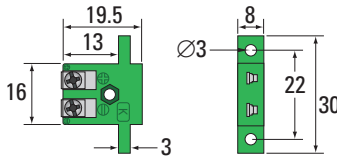
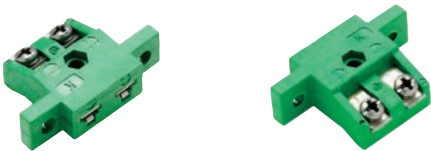

Type K IEC illustrated (F27K-I). Recommended cutout: 8.5mm x 16.5mm

IEC Colours			ANSI Colours		
Part No.	Type	Colour	Part No.	Type	Colour
F27K-I	K	Green	F27K-A	K	Yellow
F27T-I	T	Brown	F27T-A	T	Blue
F27J-I	J	Black	F27J-A	J	Black
F27N-I	N	White	F27N-A	N	Orange
F27RS-I	R/S	Red	F27RS-A	R/S	Green
F27E-I	E	Purple	F27E-A	E	Purple
F27B-I	B	Grey	F27B-A	B	Grey
F27CU	Cu	White	F27CU	Cu	White

## F30 Miniature Panel Socket - Lugged - Closed Back

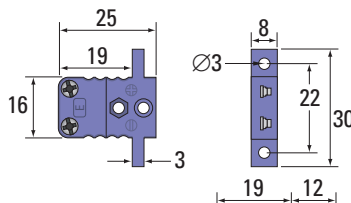
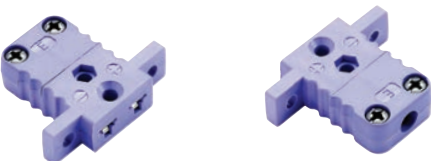

Type E IEC illustrated (F30E-I). Recommended cutout: 8.5mm x 16.5mm

IEC Colours			ANSI Colours		
Part No.	Type	Colour	Part No.	Type	Colour
F30K-I	K	Green	F30K-A	K	Yellow
F30T-I	T	Brown	F30T-A	T	Blue
F30J-I	J	Black	F30J-A	J	Black
F30N-I	N	White	F30N-A	N	Orange
F30RS-I	R/S	Red	F30RS-A	R/S	Green
F30E-I	E	Purple	F30E-A	E	Purple
F30B-I	B	Grey	F30B-A	B	Grey
F30CU	Cu	White	F30CU	Cu	White

All dimensions are in mm

# Miniature Sockets rated to 220°C

## F32 Miniature Panel Socket - Round Flanged

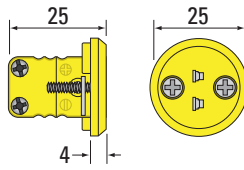

Type K ANSI illustrated (F32K-A). Cutout diameter = 22.5mm

IEC Colours			ANSI Colours		
Part No.	Type	Colour	Part No.	Type	Colour
F32K-I	K	Green	F32K-A	K	Yellow
F32T-I	T	Brown	F32T-A	T	Blue
F32J-I	J	Black	F32J-A	J	Black
F32N-I	N	White	F32N-A	N	Orange
F32RS-I	R/S	Red	F32RS-A	R/S	Green
F32E-I	E	Purple	F32E-A	E	Purple
F32B-I	B	Grey	F32B-A	B	Grey
F32CU	Cu	White	F32CU	Cu	White

## F21 Miniature Socket - PCB Bottom Mounting

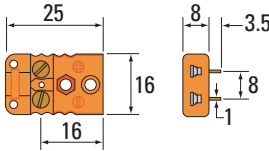
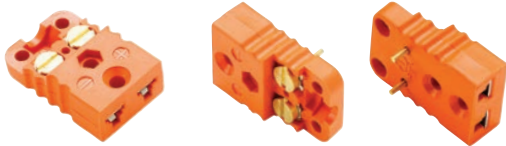

Type R/S IEC illustrated (F21RS-I)

IEC Colours			ANSI Colours		
Part No.	Type	Colour	Part No.	Type	Colour
F21K-I	K	Green	F21K-A	K	Yellow
F21T-I	T	Brown	F21T-A	T	Blue
F21J-I	J	Black	F21J-A	J	Black
F21N-I	N	White	F21N-A	N	Orange
F21RS-I	R/S	Red	F21RS-A	R/S	Green
F21E-I	E	Purple	F21E-A	E	Purple
F21B-I	B	Grey	F21B-A	B	Grey
F21CU	Cu	White	F21CU	Cu	White

## F23 Miniature Socket - PCB Rear Mounting

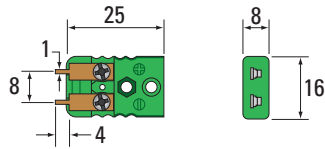

Type K IEC illustrated (F23K-I)

IEC Colours			ANSI Colours		
Part No.	Type	Colour	Part No.	Type	Colour
F23K-I	K	Green	F23K-A	K	Yellow
F23T-I	T	Brown	F23T-A	T	Blue
F23J-I	J	Black	F23J-A	J	Black
F23N-I	N	White	F23N-A	N	Orange
F23RS-I	R/S	Red	F23RS-A	R/S	Green
F23E-I	E	Purple	F23E-A	E	Purple
F23B-I	B	Grey	F23B-A	B	Grey
F23CU	Cu	White	F23CU	Cu	White

## F38 Miniature Socket - PCB Side Mounting

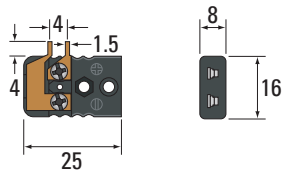

Type J IEC illustrated (F38J-I)

IEC Colours			ANSI Colours		
Part No.	Type	Colour	Part No.	Type	Colour
F38K-I	K	Green	F38K-A	K	Yellow
F38T-I	T	Brown	F38T-A	T	Blue
F38J-I	J	Black	F38J-A	J	Black
F38N-I	N	White	F38N-A	N	Orange
F38RS-I	R/S	Red	F38RS-A	R/S	Green
F38E-I	E	Purple	F38E-A	E	Purple
F38B-I	B	Grey	F38B-A	B	Grey
F38CU	Cu	White	F38CU	Cu	White

## F25 Miniature Socket - Three Pin

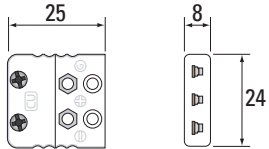

Type CU illustrated (F25CU)

IEC Colours			ANSI Colours		
Part No.	Type	Colour	Part No.	Type	Colour
F25K-I	K	Green	F25K-A	K	Yellow
F25T-I	T	Brown	F25T-A	T	Blue
F25J-I	J	Black	F25J-A	J	Black
F25N-I	N	White	F25N-A	N	Orange
F25RS-I	R/S	Red	F25RS-A	R/S	Green
F25E-I	E	Purple	F25E-A	E	Purple
F25B-I	B	Grey	F25B-A	B	Grey
F25CU	Cu	White	F25CU	Cu	White

## F31 Miniature Panel Socket - Lugged - Three Pin

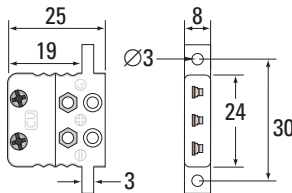

Type CU illustrated (F31CU)

IEC Colours			ANSI Colours		
Part No.	Type	Colour	Part No.	Type	Colour
F31K-I	K	Green	F31K-A	K	Yellow
F31T-I	T	Brown	F31T-A	T	Blue
F31J-I	J	Black	F31J-A	J	Black
F31N-I	N	White	F31N-A	N	Orange
F31RS-I	R/S	Red	F31RS-A	R/S	Green
F31E-I	E	Purple	F31E-A	E	Purple
F31B-I	B	Grey	F31B-A	B	Grey
F31CU	Cu	White	F31CU	Cu	White

## F92 Miniature Socket - Duplex

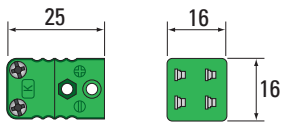
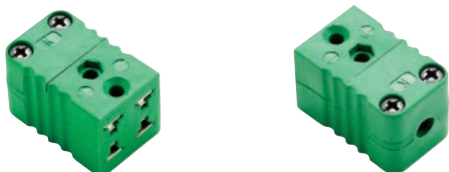

Type K IEC illustrated (F92K-I)

IEC Colours			ANSI Colours		
Part No.	Type	Colour	Part No.	Type	Colour
F92K-I	K	Green	F92K-A	K	Yellow
F92T-I	T	Brown	F92T-A	T	Blue
F92J-I	J	Black	F92J-A	J	Black
F92N-I	N	White	F92N-A	N	Orange
F92RS-I	R/S	Red	F92RS-A	R/S	Green
F92E-I	E	Purple	F92E-A	E	Purple
F92B-I	B	Grey	F92B-A	B	Grey
F92CU	Cu	White	F92CU	Cu	White

All dimensions are in mm

# High Temp Miniature Plugs rated to 350°C

## F13 Miniature High Temperature Plug



Type K illustrated (F13K)

Part No.	Type	Colour
F13K	K	●
F13T	T	●
F13J	J	●
F13N	N	●
F13RS	R/S	●
F13E	E	●
F13B	B	●
F13CU	Cu	●

## F08 Miniature High Temperature Plug - Quick Wire



Type K illustrated (F08K)

Part No.	Type	Colour
F08K	K	●
F08T	T	●
F08J	J	●
F08N	N	●
F08RS	R/S	●
F08E	E	●
F08B	B	●
F08CU	Cu	●

## F18 Miniature High Temperature Plug - Three Pin



Type K illustrated (F18K)

Part No.	Type	Colour
F18K	K	●
F18T	T	●
F18J	J	●
F18N	N	●
F18RS	R/S	●
F18E	E	●
F18B	B	●
F18CU	Cu	●

Note: All high temperature connectors are coloured brown. The thermocouple type is embossed on the body.

# High Temp Miniature Sockets rated to 350°C

## F22 Miniature High Temperature Socket



Type K illustrated (F22K)

Part No.	Type	Colour
F22K	K	●
F22T	T	●
F22J	J	●
F22N	N	●
F22RS	R/S	●
F22E	E	●
F22B	B	●
F22CU	Cu	●

## F09 Miniature High Temperature Socket - Quick Wire



Type K illustrated (F09K)

Part No.	Type	Colour
F09K	K	●
F09T	T	●
F09J	J	●
F09N	N	●
F09RS	R/S	●
F09E	E	●
F09B	B	●
F09CU	Cu	●

## F34 Miniature High Temperature Panel Socket - Rectangle Flanged



Type K illustrated (F34K). Recommended cutout: 8mm x 16.5mm

Part No.	Type	Colour
F34K	K	●
F34T	T	●
F34J	J	●
F34N	N	●
F34RS	R/S	●
F34E	E	●
F34B	B	●
F34CU	Cu	●

Note: All high temperature connectors are coloured brown. The thermocouple type is embossed on the body.

All dimensions are in mm



# High Temp Miniature Sockets rated to 350°C

## F33 Miniature High Temperature Socket - Three Pin



Type K illustrated (F33K)

Part No.	Type	Colour
F33K	K	●
F33T	T	●
F33J	J	●
F33N	N	●
F33RS	R/S	●
F33E	E	●
F33B	B	●
F33CU	Cu	●

## F35 Mini High Temp Panel Socket - Three Pin Rectangle Flanged



Type K illustrated (F35K). Recommended cutout: 8.5mm x 24.3mm

Part No.	Type	Colour
F35K	K	●
F35T	T	●
F35J	J	●
F35N	N	●
F35RS	R/S	●
F35E	E	●
F35B	B	●
F35CU	Cu	●

Note: All high temperature connectors are coloured brown. The thermocouple type is embossed on the body.

# Miniature Ceramic Plugs rated to 650°C

## F100 Miniature Ceramic Plug



Type K IEC illustrated (F100K-I)

under-side shown to illustrate colour markings

IEC Colours			ANSI Colours		
Part No.	Type	Colour	Part No.	Type	Colour
F100K-I	K	●	F100K-A	K	●
F100T-I	T	●	F100T-A	T	●
F100J-I	J	●	F100J-A	J	●
F100N-I	N	●	F100N-A	N	●
F100RS-I	R/S	●	F100RS-A	R/S	●
F100E-I	E	●	F100E-A	E	●
F100B-I	B	●	F100B-A	B	●
F100CU	Cu	○	F100CU	Cu	○

## F140 Miniature Ceramic Plug - Quick Wire



Type K IEC illustrated (F140K-I)

under-side shown to illustrate colour markings

IEC Colours			ANSI Colours		
Part No.	Type	Colour	Part No.	Type	Colour
F140K-I	K	●	F140K-A	K	●
F140T-I	T	●	F140T-A	T	●
F140J-I	J	●	F140J-A	J	●
F140N-I	N	●	F140N-A	N	●
F140RS-I	R/S	●	F140RS-A	R/S	●
F140E-I	E	●	F140E-A	E	●
F140B-I	B	●	F140B-A	B	●
F140CU	Cu	○	F140CU	Cu	○

Note: All ceramic connectors are coloured white. The thermocouple type is marked with a coloured dot on the body. For vacuum applications, connectors can be supplied without a coloured dot.

# Miniature Ceramic Sockets rated to 650°C

## F200 Miniature Ceramic Socket



Type K IEC illustrated (F200K-I)

under-side shown to illustrate colour markings

IEC Colours			ANSI Colours		
Part No.	Type	Colour	Part No.	Type	Colour
F200K-I	K	●	F200K-A	K	●
F200T-I	T	●	F200T-A	T	●
F200J-I	J	●	F200J-A	J	●
F200N-I	N	●	F200N-A	N	●
F200RS-I	R/S	●	F200RS-A	R/S	●
F200E-I	E	●	F200E-A	E	●
F200B-I	B	●	F200B-A	B	●
F200CU	Cu	○	F200CU	Cu	○

## F240 Miniature Ceramic Socket - Quick Wire



Type K IEC illustrated (F240K-I)

under-side shown to illustrate colour markings

IEC Colours			ANSI Colours		
Part No.	Type	Colour	Part No.	Type	Colour
F240K-I	K	●	F240K-A	K	●
F240T-I	T	●	F240T-A	T	●
F240J-I	J	●	F240J-A	J	●
F240N-I	N	●	F240N-A	N	●
F240RS-I	R/S	●	F240RS-A	R/S	●
F240E-I	E	●	F240E-A	E	●
F240B-I	B	●	F240B-A	B	●
F240CU	Cu	○	F240CU	Cu	○

Note: All ceramic connectors are coloured white. The thermocouple type is marked with a coloured dot on the body. For vacuum applications, connectors can be supplied without a coloured dot.

All dimensions are in mm

# Accessories for Miniature Connectors

## Cable Grommet



### Application

The cable grommet is fitted into the exit hole of the connector which prevents dirt or moisture entering the connector when used with wires or cable.

### Construction

Silicone rubber ring with collar, slit for easy use. Compresses on the wire or cable when connector is fully assembled.

**Temperature Rating**  
200°C.

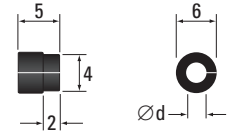

Diameter 'd'	Part codes for use with connectors: <i>F11, F16, F20, F25, F30, F31, F32, F37, F91 and F92</i> <i>Can also be used with F13 and F22 but only in conditions below 200°C</i>
0.5mm	<b>F4105</b>
1.0mm	<b>F4110</b>
1.5mm	<b>F4115</b>
3.0mm	<b>F4130</b>

## Cable and Wire Insert

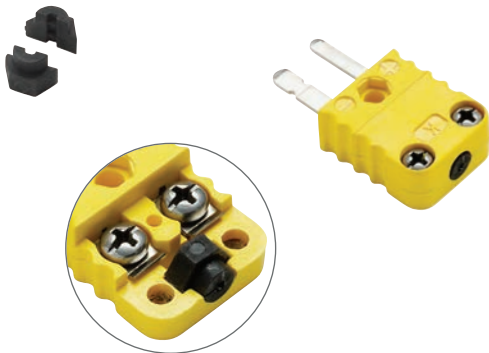

### Application

Fitted inside the connector, the insert allows the user to hold wires and cables in place, providing a strong grip without the insert protruding outside of the connector.

### Construction

Polypropylene for either round or oval cables.

**Temperature Rating**  
110°C.

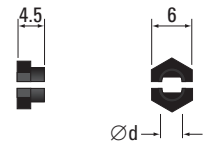

Approximate wire diameter 'd'	Round or Oval	Part codes for use with connectors: <i>F11, F13, F16, F20, F22, F25, F30, F31, F32, F37, F91 and F92</i> in applications up to 160°C
1.5mm	Round	<b>F5015</b>
3.5mm	Round	<b>F5035</b>
2.0 x 1.5mm	Oval	<b>F502015</b>

## Cable Bending Protection



### Application

Provides bending protection for small wires and cables when used with miniature connectors. Reduces potential mechanical damage to the cable. The conical end can be cut back to suit the cable.

### Construction

Silicone Rubber.

**Temperature Rating**  
200°C.

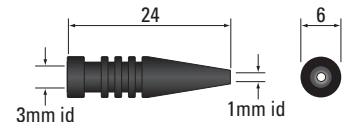

Part code for use with connectors: <i>F11, F16, F20, F25, F30, F31, F32, F37, F91 and F92</i> <i>Can also be used with F13 and F22 but only in conditions below 200°C</i>
<b>F43</b>

## Cable Clamp

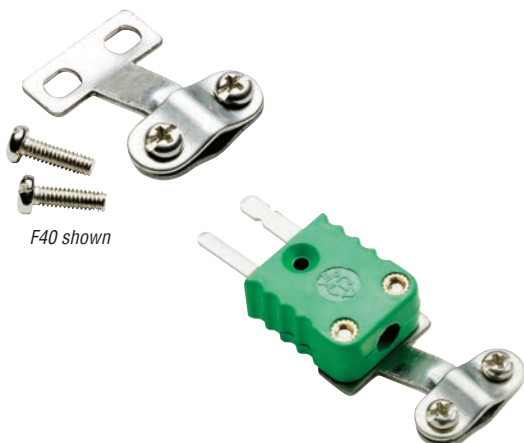

### Application

Allows the user to clamp wires and cables in place.

### Construction

Stainless steel including stainless steel screws.

### Temperature Rating

800°C (only limited by the temperature rating of the cable or connector it is attached to).

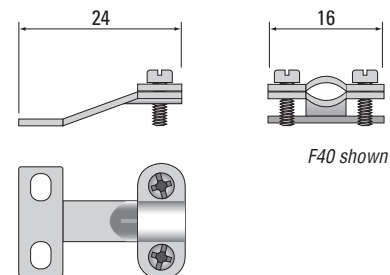

Part code for use with most 220°C and 350°C rated mini connectors <i>(F11, F13, F16, F20, F22, F25, F30, F31, F32 and F37)</i>	Part code for use with duplex 220°C rated mini connectors <i>(F91 and F92)</i>	Part code for use with 650°C rated ceramic connectors <i>(F100 and F200)</i>
<b>F40</b>	<b>F46</b>	<b>F45</b>

All dimensions are in mm

# Accessories for Miniature Connectors

## Internal Crimp/Braze Adaptor

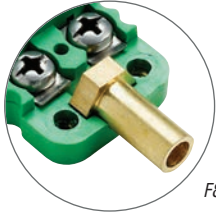
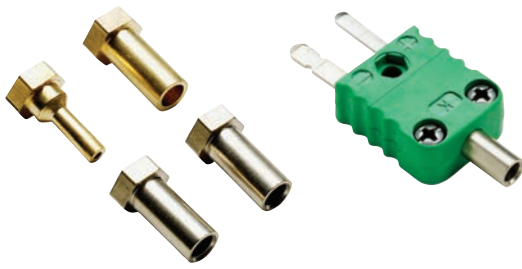

F8930B shown in plastic connector



F8715 shown in ceramic connector

### Application

This adaptor can be crimped onto a mineral insulated cable or metal tube so it may then be attached to a miniature connector. A crimp tool is available - see page 30.

Stainless steel adaptors may also be brazed. Brass adaptors can also be used to crimp some soft materials such as PVC or PFA wires and cables.

### Construction

For 220°C and 350°C range connectors: Nickel Plated Brass, Brass or Stainless Steel.

For Ceramic connectors: Stainless Steel only.

### Notes

Bore diameters listed are supplied at 'd' +0.1mm.

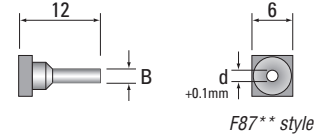
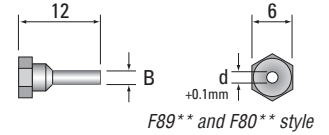

to suit tube diameter 'd'	Crimp diameter 'B'	Part codes for use with 220°C and 350°C rated connectors: F11, F13, F16, F20, F22, F25, F30, F31, F32, F37, F91 and F92			Part codes for use with 650°C rated connectors: F100 and F200
		Nickel Plated Brass	Plain Brass	Stainless Steel*	Stainless Steel*
0.5mm	2.4mm	F8905	F8905B	F8005	F8705
0.8mm (1/32")	2.4mm	F8908	-	-	-
1.0mm	2.4mm	F8910	F8910B	F8010	F8710
1.5mm	2.4mm	F8915	F8915B	F8015	F8715
1.6mm (1/16")	2.4mm	F8916	F8916B	F8016	F8716
1.8mm	3.2mm	F8918	-	-	-
2.0mm	3.2mm	F8920	F8920B	F8020	F8720
2.3mm	3.2mm	F8923	-	-	-
2.6mm	4.4mm	F8926	-	-	-
2.7mm	4.4mm	F8927	-	-	-
3.0mm	4.4mm	F8930	F8930B	F8030	F8730
3.2mm (1/8")	4.4mm	F8932	F8932B	F8032	F8732
3.4mm	4.4mm	F8934	F8934B	-	-

\* Stainless steel versions are recommended for users wishing to braze a tube to an adaptor, although they can be crimped in place with a suitable crimp tool - see page 30

## Internal Compression Tube Adaptor



### Application

This adaptor compresses onto a mineral insulated cable or metal tube so it may then be attached to a miniature connector.

For use with 220°C and 350°C versions. Not suitable for Ceramic connectors.

### Construction

All Stainless Steel parts.

### Notes

Bore diameters listed are supplied at 'd' +0.1mm.

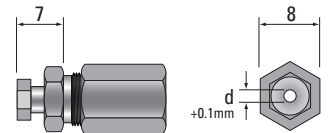

To suit tube diameter 'd'	Part codes for use with 220°C and 350°C rated connectors: F11, F13, F16, F20, F22, F25, F30, F31, F32, F37, F91 and F92
1.0mm	F7110
1.5mm	F7115
1.6mm (1/16")	F7116
3.0mm	F7130
3.2mm (1/8")	F7132

All dimensions are in mm

# Accessories for Miniature Connectors

## Panel Bracket Adaptor

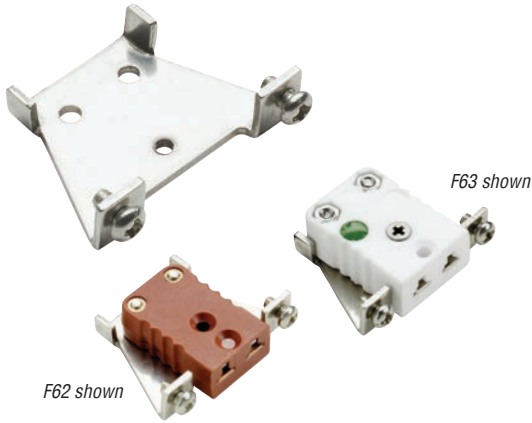

### Application

This adaptor allows the user to use a normal socket and adapt it to fit into panels.

### Construction

Stainless Steel bracket and screws.

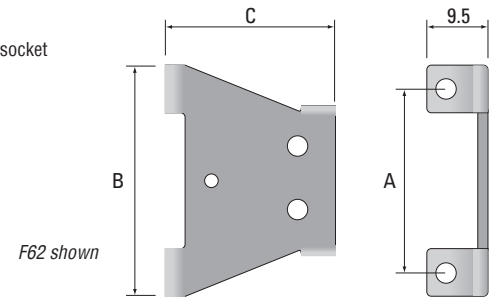

Part code for use with connectors: <b>F20 and F22</b> (A=22mm, B=27mm and C=23mm)	Part code for use with <b>ceramic</b> connector <b>F200 only</b> (A=28mm, B=34mm and C=25mm)
<b>F62</b>	<b>F63</b>

## Plastic Locking Clip

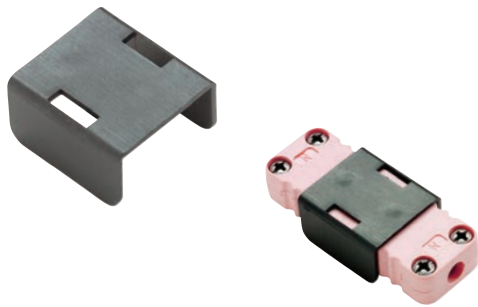

### Application

For extra protection to prevent accidental disconnection of a miniature plug and socket. Can be easily placed over a closed pair of connectors by hand (does not require special tools).

### Construction

ABS.

### Temperature Rating

110°C.

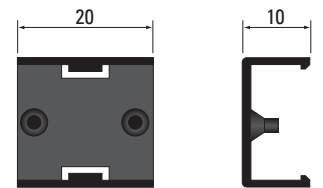

Part code for use with connectors: <b>F11 and F20</b>
<b>F69</b>

## Protection Boots



F68 shown with connector in position

### Application

When using two of these protection boots, the user can prevent moisture or dirt from entering a connected pair of connectors. One boot is required per connector.

### Construction

Silicone Rubber.

### Temperature Rating

170°C.

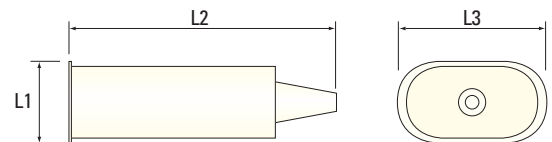

Part code for use with <b>two pin</b> connectors: <b>F11 and F20</b> (L1=12mm, L2=39mm and L3=22mm)	Part code for use with <b>three pin</b> connectors: <b>F16 and F25</b> (L1=12mm, L2=39mm and L3=30mm)
<b>F68</b>	<b>F67</b>

For F91 and F92 duplex connectors an R68 boot can be used -see page 30

## Panel Punch



### Application

This simple device can be used to punch a hole in aluminium, mild steel and some plastics up to 3.5mm thick in order to mount F26, F26H and F32 connectors.

Part code for use with connectors: <b>F26 and F26H - 17.5mm diameter cutout</b>	Part code for use with connector <b>F32 only - 22.5mm diameter cutout</b>
<b>F98</b>	<b>F99</b>

All dimensions are in mm

# Miniature Connector Panels

## Anodised Aluminium and Stainless Steel Panels - For use with Flanged 2 Pin Mini Connectors

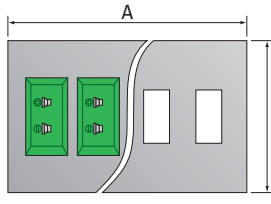
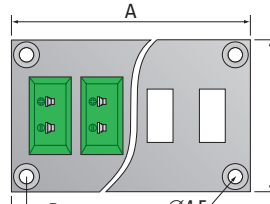
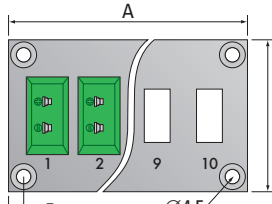
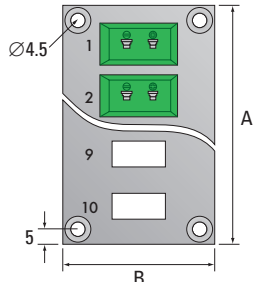
For use with connectors <b>F29</b> , <b>F29S</b> and <b>F34</b>		FFP / FSP Panel without panel mounting holes		FFS / FSS Panel with panel mounting holes		FFH Horizontal, numbered panel with panel mounting holes		FFV Vertical, numbered panel with panel mounting holes	
 <p><b>F29</b> <b>F29S</b> <b>F34*</b></p>		 <p>Panel thickness = 2mm</p>		 <p>Panel thickness = 2mm</p>		 <p>Panel thickness = 2mm</p>		 <p>Panel thickness = 2mm</p>	
No. of Channels	Dimensions A x B in mm	FFP Aluminium Panel	FSP Stainless Steel Panel	FFS Aluminium Panel	FSS Stainless Steel Panel	FFH Aluminium Panel	FFV Aluminium Panel		
1	23.5 x 47	FFP01	FSP01	FFS01	FSS01	FFH01	FFV01		
2	40 x 47	FFP02	FSP02	FFS02	FSS02	FFH02	FFV02		
4	72 x 47	FFP04	FSP04	FFS04	FSS04	FFH04	FFV04		
6	104 x 47	FFP06	FSP06	FFS06	FSS06	FFH06	FFV06		
8	136 x 47	FFP08	FSP08	FFS08	FSS08	FFH08	FFV08		
10	168 x 47	FFP10	FSP10	FFS10	FSS10	FFH10	FFV10		
12	200 x 47	FFP12	FSP12	FFS12	FSS12	FFH12	FFV12		
16	136 x 78	FFP16	–	FFS16	–	FFH16	FFV16		
20	168 x 78	FFP20	–	FFS20	–	FFH20	FFV20		
24	200 x 78	FFP24	–	FFS24	–	FFH24	FFV24		

These panels are suitable for use with the following connectors, which should be ordered separately:

**F29** - Mini Flanged Panel Socket with Bracket, **F29S** - Mini Flanged Panel Socket with Spring Clip, **F34** - Mini High Temp Flanged Panel Socket with Bracket\*

\*Note: Aluminium Panels are rated to 250°C which is lower than the rating of the connectors marked with an asterisk (F34).

## Anodised Aluminium and Stainless Steel Panels - For use with Lugged 2 Pin Mini Connectors

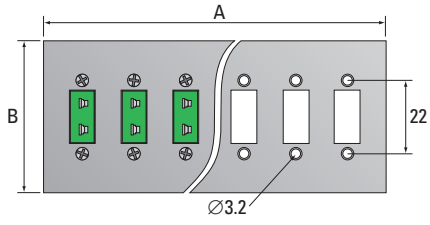
For use with connectors <b>F27</b> , <b>F30</b> , <b>F37</b> and <b>F22</b>		FCP / FSC Panel without panel mounting holes			
 <p><b>F27</b> <b>F30</b> <b>F37</b> <b>F22*</b> (with <b>F62</b> adaptor)</p>		 <p>Panel thickness = 2mm</p>			
No. of Channels	Dimensions A x B in mm	FCP Aluminium Panel	FSC Stainless Steel Panel		
1	23.5 x 47	FCP01	FSC01		
2	40 x 47	FCP02	FSC02		
4	72 x 47	FCP04	FSC04		
6	104 x 47	FCP06	FSC06		
8	136 x 47	FCP08	FSC08		
10	168 x 47	FCP10	FSC10		
12	200 x 47	FCP12	FSC12		

These panels are suitable for use with the following connectors, which should be ordered separately:

**F27** - Mini Lugged Open Back Panel Socket, **F30** - Mini Lugged Closed Back Panel Socket,

**F37** - Mini Lugged Closed Back Panel Plug and **F22** - Mini High Temp Socket with **F62** Adaptor\*

These panels are supplied with the correct screws and nuts to allow termination of lugged connectors into the panel slots.

\*Note: Aluminium Panels are rated to 250°C which is lower than the rating of the connectors marked with an asterisk (F22).

All dimensions are in mm

# Miniature Connector Panels

## Anodised Aluminium and Stainless Steel Panels - For use with 3 Pin Mini Panel Connectors

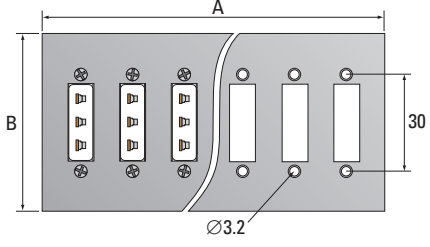
For use with connector <b>F31</b>		<b>FCT / FST</b> Panel without panel mounting holes	
 <b>F31</b>		 Panel thickness = 2mm	
No. of Channels	Dimensions A x B in mm	<b>FCT Aluminium Panel</b>	<b>FST Stainless Steel Panel</b>
2	40 x 55	<b>FCT02</b>	<b>FST02</b>
4	72 x 55	<b>FCT04</b>	<b>FST04</b>
6	104 x 55	<b>FCT06</b>	<b>FST06</b>
12	200 x 55	<b>FCT12</b>	<b>FST12</b>

These panels are suitable for use with the following connectors, which should be ordered separately:  
**F31** - Mini Three Pin Lugged Panel Socket  
 These panels are supplied with the correct screws and nuts to allow termination of lugged connectors into the panel slots.

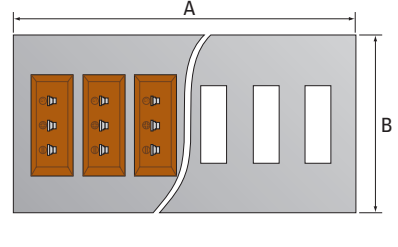
For use with connector <b>F35</b>		<b>FFT / FSF</b> Panel without panel mounting holes	
 <b>F35*</b>		 Panel thickness = 2mm	
No. of Channels	Dimensions A x B in mm	<b>FFT Aluminium Panel</b>	<b>FSF Stainless Steel Panel</b>
2	46 x 55	<b>FFT02</b>	<b>FSF02</b>
4	81 x 55	<b>FFT04</b>	<b>FSF04</b>
6	116 x 55	<b>FFT06</b>	<b>FSF06</b>
12	221 x 55	<b>FFT12</b>	<b>FSF12</b>

These panels are suitable for use with the following connectors, which should be ordered separately:  
**F35** - Mini High Temp Three Pin Flanged Panel Socket\*  
 \*Note: Aluminium Panels are rated to 250°C which is lower than the rating of the connectors marked with an asterisk (F35).

## Stainless Steel Panels - For use with Mini Ceramic Connectors

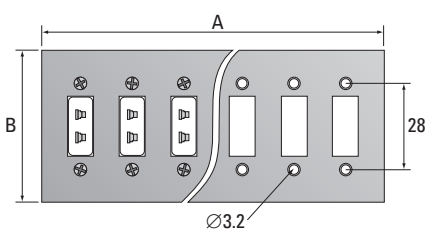
For use with connector <b>F200</b>		<b>FCC</b> Panel without panel mounting holes
 <b>F200 (with F63 adaptor)</b>		 Panel thickness = 2mm
No. of Channels	Dimensions A x B in mm	<b>FCC Stainless Steel Panel</b>
2	44 x 47	<b>FCC02</b>
4	80 x 47	<b>FCC04</b>
6	116 x 47	<b>FCC06</b>
12	224 x 47	<b>FCC12</b>

These panels are suitable for use with the following connectors, which should be ordered separately:  
**F200** - Mini Ceramic Socket with **F63** Adaptor.  
 These panels are supplied with the correct screws and nuts to allow termination of lugged connectors into the panel slots.

# Standard Thermocouple & RTD Connectors - Features

## Thermocouple & RTD Identification

- 220°C version - Body colour coded and thermocouple type indicated on body
- 350°C version - Thermocouple type indicated on body
- 650°C version - Colour dot on body

Easy wiring  
via lipped washer

## Choice of body types:

- Thermoplastic rated to 220°C
- Thermosetting plastic rated to 350°C
- Ceramic rated to 650°C

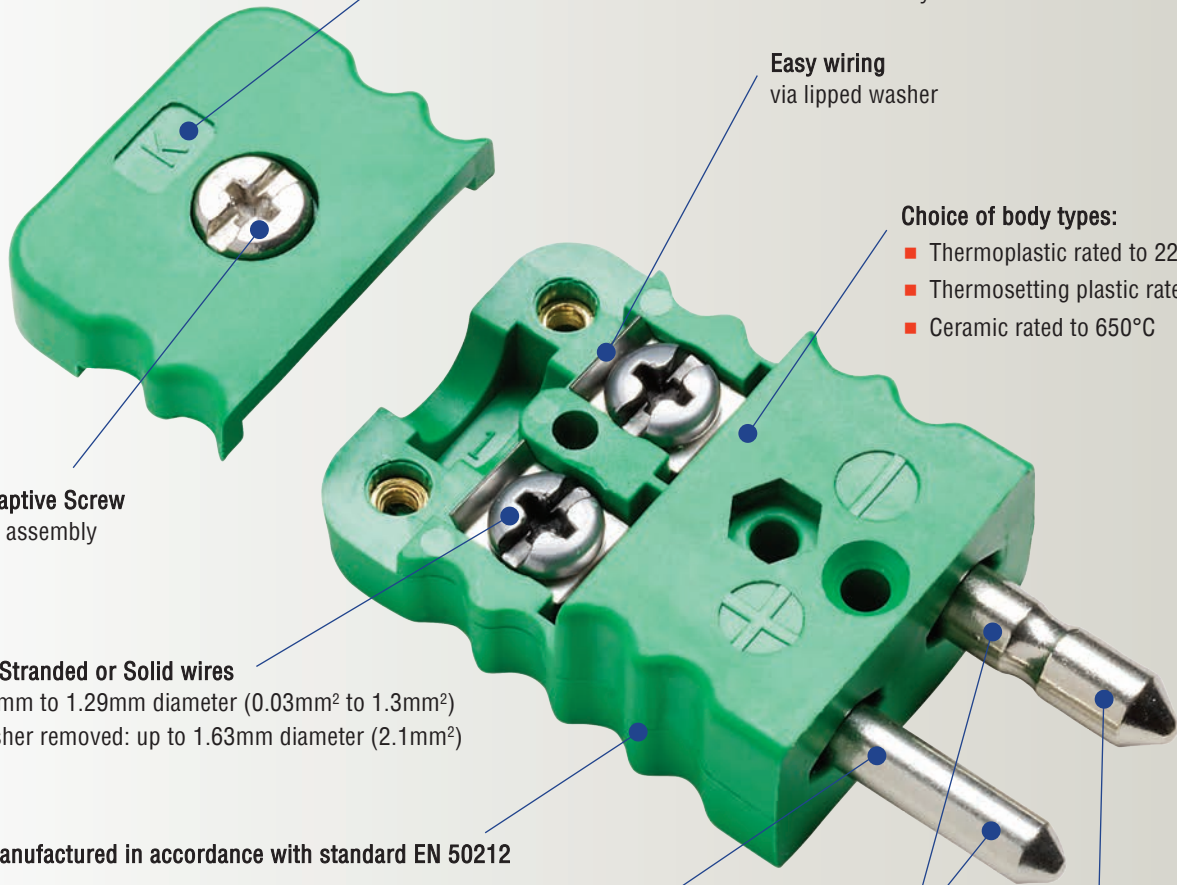

Single Captive Screw  
for quick assembly

Accepts Stranded or Solid wires  
from 0.2mm to 1.29mm diameter (0.03mm<sup>2</sup> to 1.3mm<sup>2</sup>)  
With washer removed: up to 1.63mm diameter (2.1mm<sup>2</sup>)

Manufactured in accordance with standard EN 50212

High Purity Thermocouple Alloys  
Used for male pin and female socket connections

Choice of Solid or Hollow Pins

Polarised Round Pins  
with mechanism to prevent accidental output

## Colours available: IEC, ANSI, DIN or JIS

Calibration Type	K	T	J	N	R/S	E	Cu*
Conductors	NiCr/ NiAl	Cu/ Con	Fe/ Con	NiCrSi/ NiSi	Cu/ Alloy 11	NiCr/ Con	Cu
IEC 60584.3							

Calibration Type	K	T	J	N	R/S	E	Cu*
Conductors	NiCr/ NiAl	Cu/ Con	Fe/ Con	NiCrSi/ NiSi	Cu/ Alloy 11	NiCr/ Con	Cu
ANSI MC96.1							

Calibration Type	K	T	U	J	L	R/S	E
Conductors	NiCr/ NiAl	Cu/ Con	Cu/ Con	Fe/ Con	Fe/ Con	Cu/ Alloy 11	NiCr/ Con
DIN 43714							

Calibration Type	K	T	J	N	R/S	E	Cu*
Conductors	NiCr/ NiAl	Cu/ Con	Fe/ Con	NiCrSi/ NiSi	Cu/ Alloy 11	NiCr/ Con	Cu
JIS C 1610							

\* Not an internationally recognised standard

# Standard Plugs rated to 220°C

## R11 Standard Solid Pin Plug

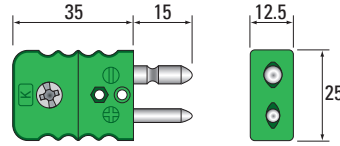

Type K IEC illustrated (R11K-I)

IEC Colours			ANSI Colours		
Part No.	Type	Colour	Part No.	Type	Colour
R11K-I	K	Green	R11K-A	K	Yellow
R11T-I	T	Brown	R11T-A	T	Blue
R11J-I	J	Black	R11J-A	J	Black
R11N-I	N	White	R11N-A	N	Orange
R11RS-I	R/S	Red	R11RS-A	R/S	Green
R11E-I	E	Purple	R11E-A	E	Purple
R11B-I	B	Grey	R11B-A	B	Grey
R11CU	Cu	White	R11CU	Cu	White

## R10 Standard Hollow Pin Plug

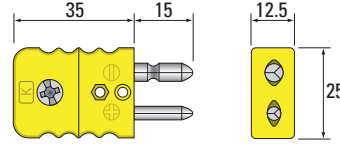
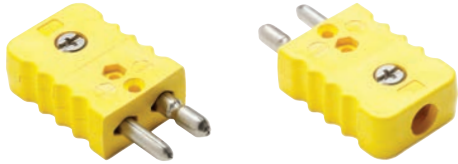

Type K ANSI illustrated (R10K-A)

IEC Colours			ANSI Colours		
Part No.	Type	Colour	Part No.	Type	Colour
R10K-I	K	Green	R10K-A	K	Yellow
R10T-I	T	Brown	R10T-A	T	Blue
R10J-I	J	Black	R10J-A	J	Black
R10N-I	N	White	R10N-A	N	Orange
R10RS-I	R/S	Red	R10RS-A	R/S	Green
R10E-I	E	Purple	R10E-A	E	Purple
R10B-I	B	Grey	R10B-A	B	Grey
R10CU	Cu	White	R10CU	Cu	White

## R14 Standard Solid Pin Plug - Quick Wire

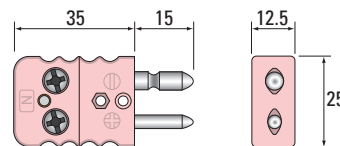
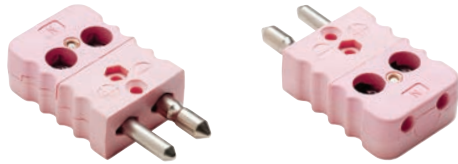

Type N IEC illustrated (R14N-I)

IEC Colours			ANSI Colours		
Part No.	Type	Colour	Part No.	Type	Colour
R14K-I	K	Green	R14K-A	K	Yellow
R14T-I	T	Brown	R14T-A	T	Blue
R14J-I	J	Black	R14J-A	J	Black
R14N-I	N	White	R14N-A	N	Orange
R14RS-I	R/S	Red	R14RS-A	R/S	Green
R14E-I	E	Purple	R14E-A	E	Purple
R14B-I	B	Grey	R14B-A	B	Grey
R14CU	Cu	White	R14CU	Cu	White

## R15 Standard Hollow Pin Plug - Quick Wire

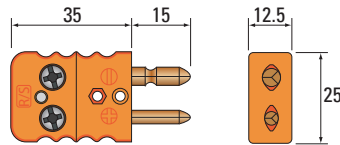
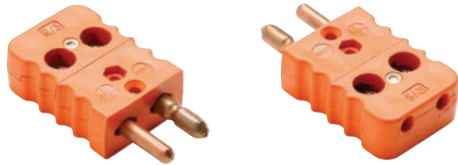

Type R/S IEC illustrated (R15RS-I)

IEC Colours			ANSI Colours		
Part No.	Type	Colour	Part No.	Type	Colour
R15K-I	K	Green	R15K-A	K	Yellow
R15T-I	T	Brown	R15T-A	T	Blue
R15J-I	J	Black	R15J-A	J	Black
R15N-I	N	White	R15N-A	N	Orange
R15RS-I	R/S	Red	R15RS-A	R/S	Green
R15E-I	E	Purple	R15E-A	E	Purple
R15B-I	B	Grey	R15B-A	B	Grey
R15CU	Cu	White	R15CU	Cu	White

## R37 Standard Solid Pin Panel Plug - Lugged

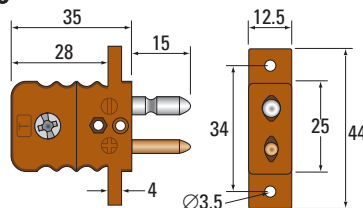
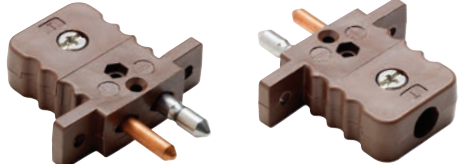

Type T IEC illustrated (R37T-I). Recommended cutout: 13mm x 26mm

IEC Colours			ANSI Colours		
Part No.	Type	Colour	Part No.	Type	Colour
R37K-I	K	Green	R37K-A	K	Yellow
R37T-I	T	Brown	R37T-A	T	Blue
R37J-I	J	Black	R37J-A	J	Black
R37N-I	N	White	R37N-A	N	Orange
R37RS-I	R/S	Red	R37RS-A	R/S	Green
R37E-I	E	Purple	R37E-A	E	Purple
R37B-I	B	Grey	R37B-A	B	Grey
R37CU	Cu	White	R37CU	Cu	White

## R36 Standard Hollow Pin Panel Plug - Lugged

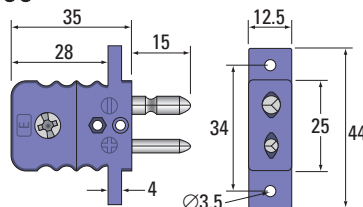
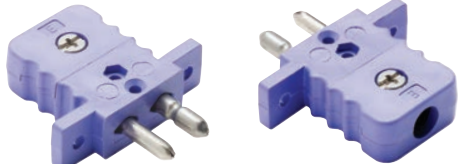

Type E IEC illustrated (R36E-I). Recommended cutout: 13mm x 26mm

IEC Colours			ANSI Colours		
Part No.	Type	Colour	Part No.	Type	Colour
R36K-I	K	Green	R36K-A	K	Yellow
R36T-I	T	Brown	R36T-A	T	Blue
R36J-I	J	Black	R36J-A	J	Black
R36N-I	N	White	R36N-A	N	Orange
R36RS-I	R/S	Red	R36RS-A	R/S	Green
R36E-I	E	Purple	R36E-A	E	Purple
R36B-I	B	Grey	R36B-A	B	Grey
R36CU	Cu	White	R36CU	Cu	White



# Standard Plugs rated to 220°C

## R16 Standard Solid Pin Plug - Three Pin

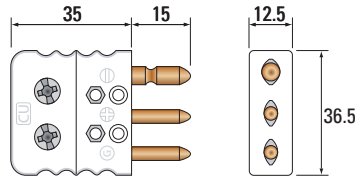
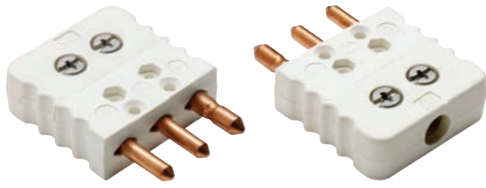

IEC Colours			ANSI Colours		
Part No.	Type	Colour	Part No.	Type	Colour
R16K-I	K	Green	R16K-A	K	Yellow
R16T-I	T	Brown	R16T-A	T	Blue
R16J-I	J	Black	R16J-A	J	Black
R16N-I	N	Pink	R16N-A	N	Orange
R16RS-I	R/S	Red	R16RS-A	R/S	Green
R16E-I	E	Purple	R16E-A	E	Purple
R16B-I	B	Grey	R16B-A	B	Grey
R16CU	Cu	White	R16CU	Cu	White

Type CU illustrated (R16CU)

## R17 Standard Hollow Pin Plug - Three Pin

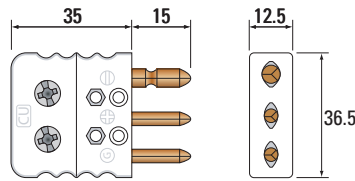
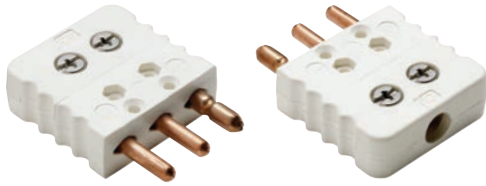

IEC Colours			ANSI Colours		
Part No.	Type	Colour	Part No.	Type	Colour
R17K-I	K	Green	R17K-A	K	Yellow
R17T-I	T	Brown	R17T-A	T	Blue
R17J-I	J	Black	R17J-A	J	Black
R17N-I	N	Pink	R17N-A	N	Orange
R17RS-I	R/S	Red	R17RS-A	R/S	Green
R17E-I	E	Purple	R17E-A	E	Purple
R17B-I	B	Grey	R17B-A	B	Grey
R17CU	Cu	White	R17CU	Cu	White

Type CU illustrated (R17CU)

## R91 Standard Solid Pin Plug - Duplex

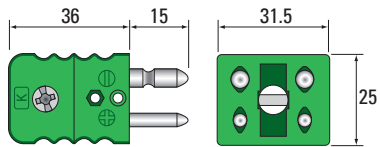
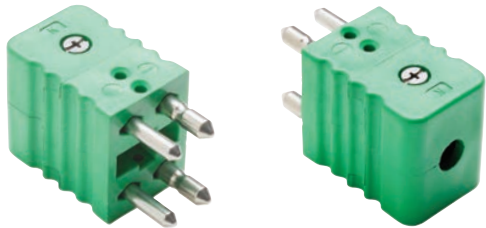

IEC Colours			ANSI Colours		
Part No.	Type	Colour	Part No.	Type	Colour
R91K-I	K	Green	R91K-A	K	Yellow
R91T-I	T	Brown	R91T-A	T	Blue
R91J-I	J	Black	R91J-A	J	Black
R91N-I	N	Pink	R91N-A	N	Orange
R91RS-I	R/S	Red	R91RS-A	R/S	Green
R91E-I	E	Purple	R91E-A	E	Purple
R91B-I	B	Grey	R91B-A	B	Grey
R91CU	Cu	White	R91CU	Cu	White

Type K IEC illustrated (R91K-I)

## R90 Standard Hollow Pin Plug - Duplex

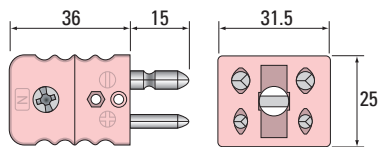
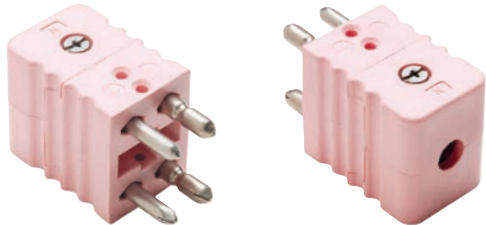

IEC Colours			ANSI Colours		
Part No.	Type	Colour	Part No.	Type	Colour
R90K-I	K	Green	R90K-A	K	Yellow
R90T-I	T	Brown	R90T-A	T	Blue
R90J-I	J	Black	R90J-A	J	Black
R90N-I	N	Pink	R90N-A	N	Orange
R90RS-I	R/S	Red	R90RS-A	R/S	Green
R90E-I	E	Purple	R90E-A	E	Purple
R90B-I	B	Grey	R90B-A	B	Grey
R90CU	Cu	White	R90CU	Cu	White

Type N IEC illustrated (R90N-I)

All dimensions are in mm

# Standard Sockets rated to 220°C

## R20 Standard Socket



Type K IEC illustrated (R20K-I)

IEC Colours			ANSI Colours		
Part No.	Type	Colour	Part No.	Type	Colour
R20K-I	K	Green	R20K-A	K	Yellow
R20T-I	T	Brown	R20T-A	T	Blue
R20J-I	J	Black	R20J-A	J	Black
R20N-I	N	Pink	R20N-A	N	Orange
R20RS-I	R/S	Red	R20RS-A	R/S	Green
R20E-I	E	Purple	R20E-A	E	Purple
R20B-I	B	Grey	R20B-A	B	Grey
R20CU	Cu	White	R20CU	Cu	White

## R24 Standard Socket - Quick Wire



Type T IEC illustrated (R24T-I)

IEC Colours			ANSI Colours		
Part No.	Type	Colour	Part No.	Type	Colour
R24K-I	K	Green	R24K-A	K	Yellow
R24T-I	T	Brown	R24T-A	T	Blue
R24J-I	J	Black	R24J-A	J	Black
R24N-I	N	Pink	R24N-A	N	Orange
R24RS-I	R/S	Red	R24RS-A	R/S	Green
R24E-I	E	Purple	R24E-A	E	Purple
R24B-I	B	Grey	R24B-A	B	Grey
R24CU	Cu	White	R24CU	Cu	White

## R26 Standard Panel Socket - Square Flanged with Bracket

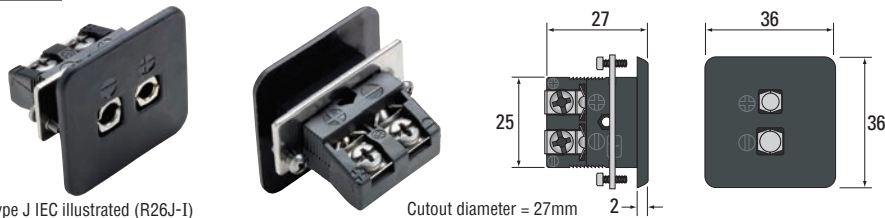

Type J IEC illustrated (R26J-I)

IEC Colours			ANSI Colours		
Part No.	Type	Colour	Part No.	Type	Colour
R26K-I	K	Green	R26K-A	K	Yellow
R26T-I	T	Brown	R26T-A	T	Blue
R26J-I	J	Black	R26J-A	J	Black
R26N-I	N	Pink	R26N-A	N	Orange
R26RS-I	R/S	Red	R26RS-A	R/S	Green
R26E-I	E	Purple	R26E-A	E	Purple
R26B-I	B	Grey	R26B-A	B	Grey
R26CU	Cu	White	R26CU	Cu	White

## R26H Standard Panel Socket - Square Flanged with Holes & Bracket

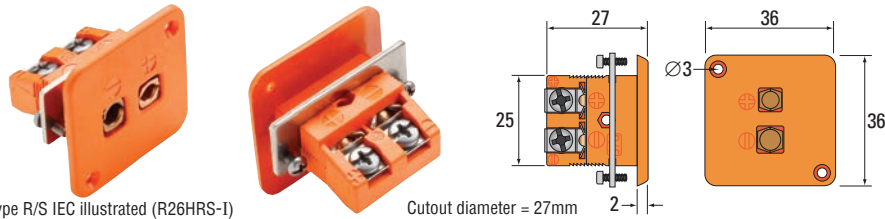

Type R/S IEC illustrated (R26HRS-I)

IEC Colours			ANSI Colours		
Part No.	Type	Colour	Part No.	Type	Colour
R26HK-I	K	Green	R26HK-A	K	Yellow
R26HT-I	T	Brown	R26HT-A	T	Blue
R26HJ-I	J	Black	R26HJ-A	J	Black
R26HN-I	N	Pink	R26HN-A	N	Orange
R26HRS-I	R/S	Red	R26HRS-A	R/S	Green
R26HE-I	E	Purple	R26HE-A	E	Purple
R26HB-I	B	Grey	R26HB-A	B	Grey
R26HCU	Cu	White	R26HCU	Cu	White

## R28 Standard Panel Socket - for use with Mounting Kit



Type K ANSI illustrated (R28K-A) - see page 32 for mounting kit. Recommended cutout: 13mm x 25.8mm

IEC Colours			ANSI Colours		
Part No.	Type	Colour	Part No.	Type	Colour
R28K-I	K	Green	R28K-A	K	Yellow
R28T-I	T	Brown	R28T-A	T	Blue
R28J-I	J	Black	R28J-A	J	Black
R28N-I	N	Pink	R28N-A	N	Orange
R28RS-I	R/S	Red	R28RS-A	R/S	Green
R28E-I	E	Purple	R28E-A	E	Purple
R28B-I	B	Grey	R28B-A	B	Grey
R28CU	Cu	White	R28CU	Cu	White

## R29 Standard Panel Socket - Rectangle Flanged with Bracket

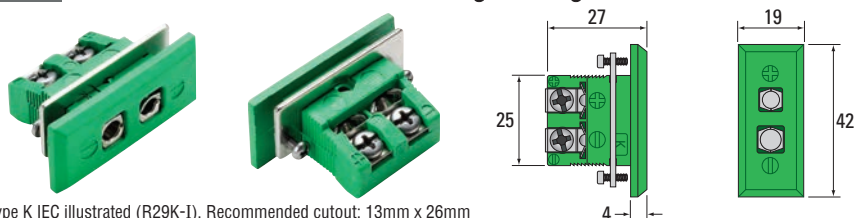

Type K IEC illustrated (R29K-I). Recommended cutout: 13mm x 26mm

IEC Colours			ANSI Colours		
Part No.	Type	Colour	Part No.	Type	Colour
R29K-I	K	Green	R29K-A	K	Yellow
R29T-I	T	Brown	R29T-A	T	Blue
R29J-I	J	Black	R29J-A	J	Black
R29N-I	N	Pink	R29N-A	N	Orange
R29RS-I	R/S	Red	R29RS-A	R/S	Green
R29E-I	E	Purple	R29E-A	E	Purple
R29B-I	B	Grey	R29B-A	B	Grey
R29CU	Cu	White	R29CU	Cu	White

## R29S Standard Panel Socket - Rectangle Flanged with Spring Clip



Type N IEC illustrated (R29SN-I). Recommended cutout: 13mm x 26mm

IEC Colours			ANSI Colours		
Part No.	Type	Colour	Part No.	Type	Colour
R29SK-I	K	Green	R29SK-A	K	Yellow
R29ST-I	T	Brown	R29ST-A	T	Blue
R29SJ-I	J	Black	R29SJ-A	J	Black
R29SN-I	N	Pink	R29SN-A	N	Orange
R29SRS-I	R/S	Red	R29SRS-A	R/S	Green
R29SE-I	E	Purple	R29SE-A	E	Purple
R29SB-I	B	Grey	R29SB-A	B	Grey
R29SCU	Cu	White	R29SCU	Cu	White

All dimensions are in mm

# Standard Sockets rated to 220°C

## R27 Standard Panel Socket - Lugged - Open Back



Type J IEC illustrated (R27J-I). Recommended cutout: 13mm x 26mm

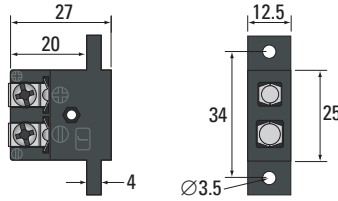

IEC Colours			ANSI Colours		
Part No.	Type	Colour	Part No.	Type	Colour
R27K-I	K	Green	R27K-A	K	Yellow
R27T-I	T	Brown	R27T-A	T	Blue
R27J-I	J	Black	R27J-A	J	Black
R27N-I	N	Pink	R27N-A	N	Orange
R27RS-I	R/S	Red	R27RS-A	R/S	Green
R27E-I	E	Purple	R27E-A	E	Purple
R27B-I	B	Grey	R27B-A	B	Grey
R27CU	Cu	White	R27CU	Cu	White

## R30 Standard Panel Socket - Lugged - Closed Back

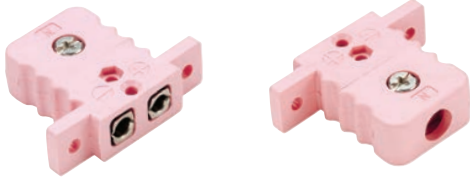

Type N IEC illustrated (R30N-I). Recommended cutout: 13mm x 26mm

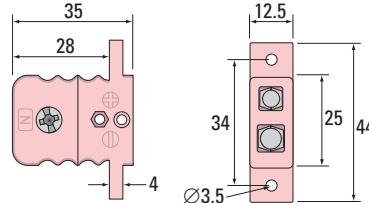

IEC Colours			ANSI Colours		
Part No.	Type	Colour	Part No.	Type	Colour
R30K-I	K	Green	R30K-A	K	Yellow
R30T-I	T	Brown	R30T-A	T	Blue
R30J-I	J	Black	R30J-A	J	Black
R30N-I	N	Pink	R30N-A	N	Orange
R30RS-I	R/S	Red	R30RS-A	R/S	Green
R30E-I	E	Purple	R30E-A	E	Purple
R30B-I	B	Grey	R30B-A	B	Grey
R30CU	Cu	White	R30CU	Cu	White

## R32 Standard Panel Socket - Round Flanged



Type K ANSI illustrated (R32K-A). Cutout diameter = 28.3mm

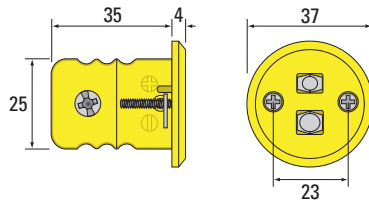

IEC Colours			ANSI Colours		
Part No.	Type	Colour	Part No.	Type	Colour
R32K-I	K	Green	R32K-A	K	Yellow
R32T-I	T	Brown	R32T-A	T	Blue
R32J-I	J	Black	R32J-A	J	Black
R32N-I	N	Pink	R32N-A	N	Orange
R32RS-I	R/S	Red	R32RS-A	R/S	Green
R32E-I	E	Purple	R32E-A	E	Purple
R32B-I	B	Grey	R32B-A	B	Grey
R32CU	Cu	White	R32CU	Cu	White

## R25 Standard Socket - Three Pin



Type CU illustrated (R25CU)

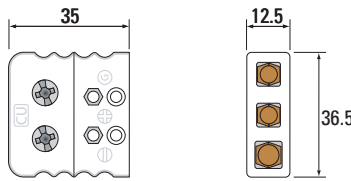

IEC Colours			ANSI Colours		
Part No.	Type	Colour	Part No.	Type	Colour
R25K-I	K	Green	R25K-A	K	Yellow
R25T-I	T	Brown	R25T-A	T	Blue
R25J-I	J	Black	R25J-A	J	Black
R25N-I	N	Pink	R25N-A	N	Orange
R25RS-I	R/S	Red	R25RS-A	R/S	Green
R25E-I	E	Purple	R25E-A	E	Purple
R25B-I	B	Grey	R25B-A	B	Grey
R25CU	Cu	White	R25CU	Cu	White

## R31 Standard Panel Socket - Lugged - Three Pin



Type T IEC illustrated (R31T-I). Recommended cutout: 13.5mm x 37mm

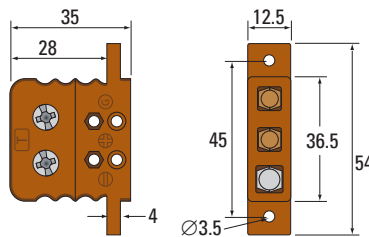

IEC Colours			ANSI Colours		
Part No.	Type	Colour	Part No.	Type	Colour
R31K-I	K	Green	R31K-A	K	Yellow
R31T-I	T	Brown	R31T-A	T	Blue
R31J-I	J	Black	R31J-A	J	Black
R31N-I	N	Pink	R31N-A	N	Orange
R31RS-I	R/S	Red	R31RS-A	R/S	Green
R31E-I	E	Purple	R31E-A	E	Purple
R31B-I	B	Grey	R31B-A	B	Grey
R31CU	Cu	White	R31CU	Cu	White

## R92 Standard Socket - Duplex



Type K IEC illustrated (R92K-I)

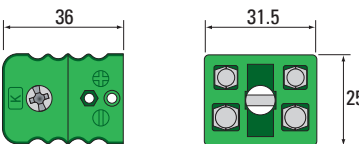

IEC Colours			ANSI Colours		
Part No.	Type	Colour	Part No.	Type	Colour
R92K-I	K	Green	R92K-A	K	Yellow
R92T-I	T	Brown	R92T-A	T	Blue
R92J-I	J	Black	R92J-A	J	Black
R92N-I	N	Pink	R92N-A	N	Orange
R92RS-I	R/S	Red	R92RS-A	R/S	Green
R92E-I	E	Purple	R92E-A	E	Purple
R92B-I	B	Grey	R92B-A	B	Grey
R92CU	Cu	White	R92CU	Cu	White

All dimensions are in mm

# High Temp Standard Plugs rated to 350°C

## R13 Standard High Temperature Solid Pin Plug



Type K illustrated (R13K)

Part No.	Type	Colour
R13K	K	●
R13T	T	●
R13J	J	●
R13N	N	●
R13RS	R/S	●
R13E	E	●
R13B	B	●
R13CU	Cu	●

## R12 Standard High Temperature Hollow Pin Plug



Type T illustrated (R12T)

Part No.	Type	Colour
R12K	K	●
R12T	T	●
R12J	J	●
R12N	N	●
R12RS	R/S	●
R12E	E	●
R12B	B	●
R12CU	Cu	●

## R08 Standard High Temp Solid Pin Plug - Quick Wire



Type K illustrated (R08K)

Part No.	Type	Colour
R08K	K	●
R08T	T	●
R08J	J	●
R08N	N	●
R08RS	R/S	●
R08E	E	●
R08B	B	●
R08CU	Cu	●

## R07 Standard High Temp Hollow Pin Plug - Quick Wire



Type K illustrated (R07K)

Part No.	Type	Colour
R07K	K	●
R07T	T	●
R07J	J	●
R07N	N	●
R07RS	R/S	●
R07E	E	●
R07B	B	●
R07CU	Cu	●

## R18 Standard High Temp Solid Pin Plug - Three Pin



Type K illustrated (R18K)

Part No.	Type	Colour
R18K	K	●
R18T	T	●
R18J	J	●
R18N	N	●
R18RS	R/S	●
R18E	E	●
R18B	B	●
R18CU	Cu	●

## R19 Standard High Temp Hollow Pin Plug - Three Pin



Type K illustrated (R19K)

Part No.	Type	Colour
R19K	K	●
R19T	T	●
R19J	J	●
R19N	N	●
R19RS	R/S	●
R19E	E	●
R19B	B	●
R19CU	Cu	●

Note: All high temperature connectors are coloured brown. The thermocouple type is embossed on the body.

All dimensions are in mm

# High Temp Standard Sockets rated to 350°C

## R22 Standard High Temperature Socket

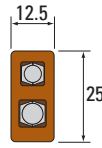
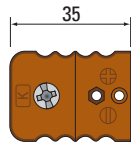

Type K illustrated (R22K)

Part No.	Type	Colour
R22K	K	●
R22T	T	●
R22J	J	●
R22N	N	●
R22RS	R/S	●
R22E	E	●
R22B	B	●
R22CU	Cu	●

## R09 Standard High Temperature Socket - Quick Wire

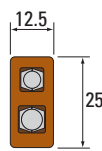
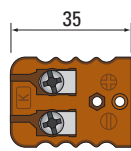

Type K illustrated (R09K)

Part No.	Type	Colour
R09K	K	●
R09T	T	●
R09J	J	●
R09N	N	●
R09RS	R/S	●
R09E	E	●
R09B	B	●
R09CU	Cu	●

## R34 Standard High Temp Panel Socket - Rectangle Flanged

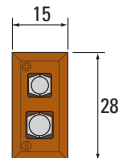
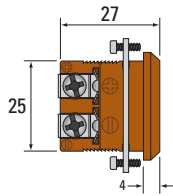

Recommended cutout: 13mm x 26mm. Type K illustrated (R34K)

Part No.	Type	Colour
R34K	K	●
R34T	T	●
R34J	J	●
R34N	N	●
R34RS	R/S	●
R34E	E	●
R34B	B	●
R34CU	Cu	●

## R33 Standard High Temperature Socket - Three Pin

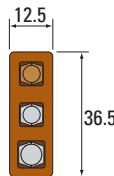
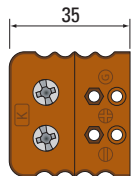

Type K illustrated (R33K)

Part No.	Type	Colour
R33K	K	●
R33T	T	●
R33J	J	●
R33N	N	●
R33RS	R/S	●
R33E	E	●
R33B	B	●
R33CU	Cu	●

## R35 Standard High Temp Panel Socket - Rectangle Flanged - Three Pin

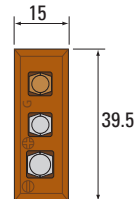
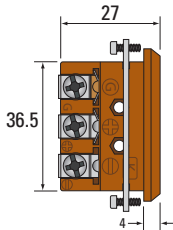

Type K illustrated (R35). Recommended cutout: 13mm x 37mm

Part No.	Type	Colour
R35K	K	●
R35T	T	●
R35J	J	●
R35N	N	●
R35RS	R/S	●
R35E	E	●
R35B	B	●
R35CU	Cu	●

Note: All high temperature connectors are coloured brown. The thermocouple type is embossed on the body.

All dimensions are in mm

# Standard Ceramic Plugs rated to 650°C

## R100 Standard Ceramic Solid Pin Plug



Type K IEC illustrated (R100K-I)

under-side shown to illustrate colour markings

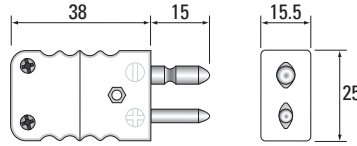

IEC Colours			ANSI Colours		
Part No.	Type	Colour	Part No.	Type	Colour
R100K-I	K	Green	R100K-A	K	Yellow
R100T-I	T	Brown	R100T-A	T	Blue
R100J-I	J	Black	R100J-A	J	Black
R100N-I	N	White	R100N-A	N	Orange
R100RS-I	R/S	Red	R100RS-A	R/S	Green
R100E-I	E	Purple	R100E-A	E	Purple
R100B-I	B	Grey	R100B-A	B	Grey
R100CU	Cu	White	R100CU	Cu	White

## R120 Standard Ceramic Hollow Pin Plug



Type K ANSI illustrated (R120K-A)

under-side shown to illustrate colour markings

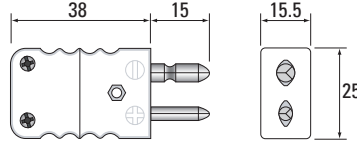

IEC Colours			ANSI Colours		
Part No.	Type	Colour	Part No.	Type	Colour
R120K-I	K	Green	R120K-A	K	Yellow
R120T-I	T	Brown	R120T-A	T	Blue
R120J-I	J	Black	R120J-A	J	Black
R120N-I	N	White	R120N-A	N	Orange
R120RS-I	R/S	Red	R120RS-A	R/S	Green
R120E-I	E	Purple	R120E-A	E	Purple
R120B-I	B	Grey	R120B-A	B	Grey
R120CU	Cu	White	R120CU	Cu	White

## R130 Standard Ceramic Solid Pin Plug - Quick Wire



Type K IEC illustrated (R130K-I)

under-side shown to illustrate colour markings

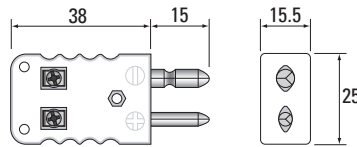

IEC Colours			ANSI Colours		
Part No.	Type	Colour	Part No.	Type	Colour
R130K-I	K	Green	R130K-A	K	Yellow
R130T-I	T	Brown	R130T-A	T	Blue
R130J-I	J	Black	R130J-A	J	Black
R130N-I	N	White	R130N-A	N	Orange
R130RS-I	R/S	Red	R130RS-A	R/S	Green
R130E-I	E	Purple	R130E-A	E	Purple
R130B-I	B	Grey	R130B-A	B	Grey
R130CU	Cu	White	R130CU	Cu	White

## R140 Standard Ceramic Hollow Pin Plug - Quick Wire



Type K ANSI illustrated (R140K-A)

under-side shown to illustrate colour markings

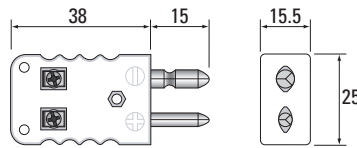

IEC Colours			ANSI Colours		
Part No.	Type	Colour	Part No.	Type	Colour
R140K-I	K	Green	R140K-A	K	Yellow
R140T-I	T	Brown	R140T-A	T	Blue
R140J-I	J	Black	R140J-A	J	Black
R140N-I	N	White	R140N-A	N	Orange
R140RS-I	R/S	Red	R140RS-A	R/S	Green
R140E-I	E	Purple	R140E-A	E	Purple
R140B-I	B	Grey	R140B-A	B	Grey
R140CU	Cu	White	R140CU	Cu	White

Note: All ceramic connectors are coloured white. The thermocouple type is marked with a coloured dot on the body. For vacuum applications, connectors can be supplied without a coloured dot.

# Standard Ceramic Sockets rated to 650°C

## R200 Standard Ceramic Socket



Type K IEC illustrated (R200K-I)

under-side shown to illustrate colour markings

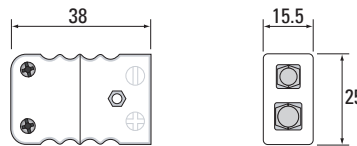

IEC Colours			ANSI Colours		
Part No.	Type	Colour	Part No.	Type	Colour
R200K-I	K	Green	R200K-A	K	Yellow
R200T-I	T	Brown	R200T-A	T	Blue
R200J-I	J	Black	R200J-A	J	Black
R200N-I	N	White	R200N-A	N	Orange
R200RS-I	R/S	Red	R200RS-A	R/S	Green
R200E-I	E	Purple	R200E-A	E	Purple
R200B-I	B	Grey	R200B-A	B	Grey
R200CU	Cu	White	R200CU	Cu	White

## R240 Standard Ceramic Socket - Quick Wire



Type K IEC illustrated (R240K-I)

under-side shown to illustrate colour markings

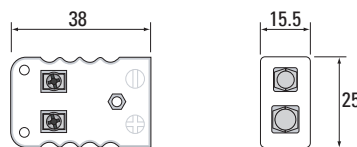

IEC Colours			ANSI Colours		
Part No.	Type	Colour	Part No.	Type	Colour
R240K-I	K	Green	R240K-A	K	Yellow
R240T-I	T	Brown	R240T-A	T	Blue
R240J-I	J	Black	R240J-A	J	Black
R240N-I	N	White	R240N-A	N	Orange
R240RS-I	R/S	Red	R240RS-A	R/S	Green
R240E-I	E	Purple	R240E-A	E	Purple
R240B-I	B	Grey	R240B-A	B	Grey
R240CU	Cu	White	R240CU	Cu	White

Note: All ceramic connectors are coloured white. The thermocouple type is marked with a coloured dot on the body. For vacuum applications, connectors can be supplied without a coloured dot.

All dimensions are in mm

# Heavy Duty Multi Connectors rated to 220°C

## RPP Standard 6 way Heavy Duty Plug

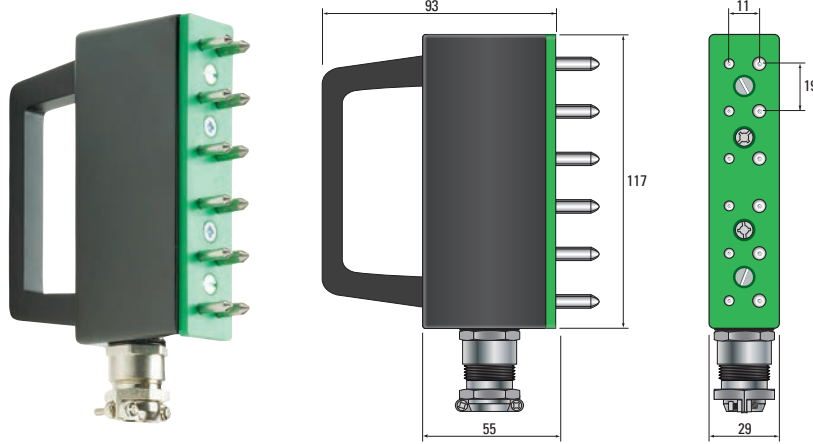

Type K IEC illustrated (RPPK-I). Cable gland suitable for cables up to 16mm diameter

IEC Colours			ANSI Colours		
Part No.	Type	Colour	Part No.	Type	Colour
RPPK-I	K	Green	RPPK-A	K	Yellow
RPPT-I	T	Brown	RPPT-A	T	Blue
RPPJ-I	J	Black	RPPJ-A	J	Black
RPPN-I	N	Pink	RPPN-A	N	Orange
RPPRS-I	R/S	Orange	RPPRS-A	R/S	Green
RPPE-I	E	Purple	RPPE-A	E	Purple
RPPB-I	B	Grey	RPPB-A	B	Grey
RPPCU	Cu	White	RPPCU	Cu	White

## RPS Standard 6 way Heavy Duty Socket

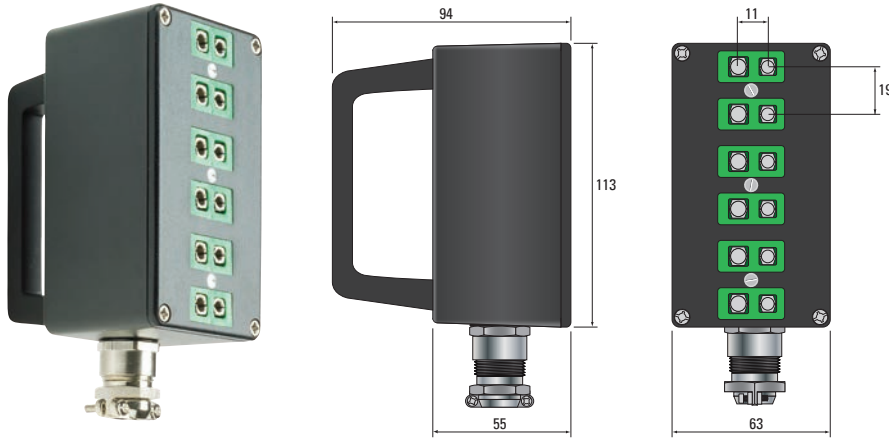

Type K IEC illustrated (RPSK-I). Cable gland suitable for cables up to 16mm diameter

IEC Colours			ANSI Colours		
Part No.	Type	Colour	Part No.	Type	Colour
RPSK-I	K	Green	RPSK-A	K	Yellow
RPST-I	T	Brown	RPST-A	T	Blue
RPSJ-I	J	Black	RPSJ-A	J	Black
RPSN-I	N	Pink	RPSN-A	N	Orange
RPSRS-I	R/S	Orange	RPSRS-A	R/S	Green
RPSE-I	E	Purple	RPSE-A	E	Purple
RPSB-I	B	Grey	RPSB-A	B	Grey
RPSCU	Cu	White	RPSCU	Cu	White

Note: The RPP\*-\* plug is compatible with the RPS\*-\* socket or the RWS06 panel

## DIN Rail Mounted Terminal Blocks

### DTB DIN Rail Mounted Thermocouple Terminal Blocks

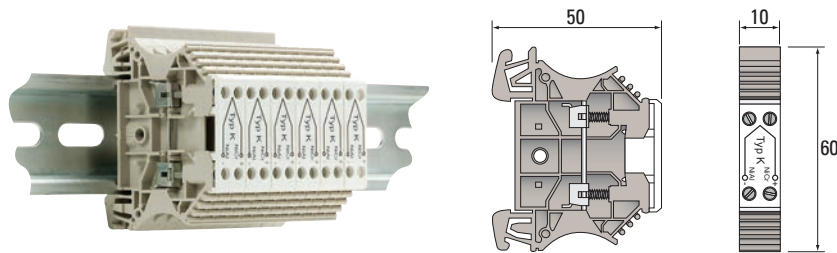

A group of six Type K (DTBK) terminal blocks is illustrated

These Thermocouple Terminal Blocks are designed to allow users to connect thermocouple wires or cables on a DIN rail mounting system. Input and output terminals are situated at the top and the bottom of the block and are linked using the appropriate thermocouple material.

All blocks are suitable for mounting onto TS35 DIN Rail (35mm x 7.5mm). DIN Rail is available in lengths of 200, 400 and 500mm but can be cut by the user to the required length.

One end plate (DTBEND) is recommended per group of terminal blocks.

Part No.	Type	Colour
DTBK	K	Green
DTBT	T	Brown
DTBJ	J	Black
DTBN	N	Pink
DTBRS	R/S	Orange
DTBE	E	Purple
DTBB	B	Grey
DTBEND	End Plate	White

TS 35 DIN Rail for DIN Rail Mounted Connectors	
DIN Rail Length	Part No. for DIN Rail
200mm	DR200
400mm	DR400
500mm	DR500

All dimensions are in mm

# Barrier Terminal Blocks rated to 220°C

## BTS Interconnecting Barrier Terminal Blocks



Type K IEC illustrated (BTSK-I)  
Terminal lugs and end caps are included



Shown as three units connected

### Application

These interconnecting Barrier Terminal Blocks are suitable for use with all thermocouple types as well as Copper for other sensors such as RTD's. Each single block comes complete with terminal lugs and end caps. All are colour coded as shown for easy identification and are temperature rated to 220°C.

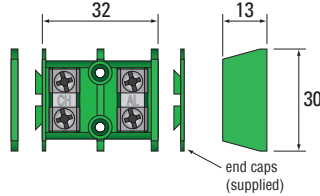

IEC Colours			ANSI Colours		
Part No.	Type	Colour	Part No.	Type	Colour
BTSK-I	K	Green	BTSK-A	K	Yellow
BTST-I	T	Brown	BTST-A	T	Blue
BTSJ-I	J	Black	BTSJ-A	J	Black
BTSN-I	N	White	BTSN-A	N	Orange
BTSRS-I	R/S	Red	BTSRS-A	R/S	Green
BTSE-I	E	Purple	BTSE-A	E	Purple
BTSB-I	B	Grey	BTSB-A	B	Grey
BTSCU	Cu	White	BTSCU	Cu	White

## TL Spare Terminal Lugs



### Application

Whilst BTS terminal blocks are supplied complete with terminal lugs, it is possible to purchase them separately as spares or for a new application.

### Construction

All lugs are made from the relevant thermocouple material. Terminal Lugs are spares for the Barrier Terminal Strip itself.

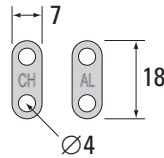

Thermocouple Material	Identification Marking	Part No. for Spare Terminal Lugs
Chromel (K+, E+)	CH	TLCH
Alumel (K-)	AL	TLAL
Iron (J+)	IR	TLIR
Constantan (T-, J-, E-)	CO	TLCO
Copper (T+, RCB+, CU+, CU-)	CP	TLCU
Cupronic (RCB-)	11	TLCUPR
Nicrosil (N+)	N+	TLNIC
Nisil (N-)	N-	TLNIS

# Thermocouple & RTD Crimp Lugs

## SL & RL Spade and Ring Crimp Lugs



### Application

These thermocouple & RTD spade and ring lugs are ideal for attaching to the end of thermocouple (or RTD) leads or alternatively thermocouple extension cable. Using them eliminates any potential problems that may occur by introducing other alloys into the thermocouple circuit which could affect the accuracy of the thermocouple. Both designs of lug will accommodate all wire sizes up to 1.00mm (18 AWG).

### Construction

All lugs are made from the relevant thermocouple material. Ring and Spade lugs are crimped to cables.

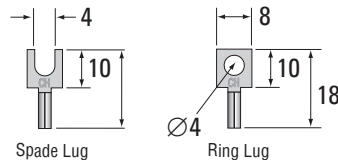

Thermocouple Material	Identification Marking	Part No. for Spade and Ring Lugs	
		Spade Lugs	Ring Lugs
Chromel (K+, E+)	CH	SLCH	RLCH
Alumel (K-)	AL	SLAL	RLAL
Iron (J+)	IR	SLIR	RLIR
Constantan (T-, J-, E-)	CO	SLCO	RLCO
Copper (T+, RCB+, CU+, CU-)	CP	SLCU	RLCU
Cupronic (RCB-)	11	SLCUPR	RLCUPR
Nicrosil (N+)	N+	SLNIC	RLNIC
Nisil (N-)	N-	SLNIS	RLNIS



# Accessories for Standard Connectors

## Cable Grommet



### Application

The cable grommet is fitted into the exit hole of the connector which prevents dirt or moisture entering the connector when used with wires or cable.

### Construction

Silicone rubber ring with collar, slit for easy use. Compresses on the wire or cable when connector is fully assembled.

**Temperature Rating**  
200°C.

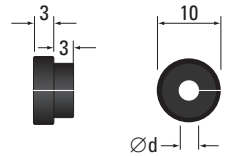

Diameter 'd'	Part codes for use with connectors: <i>R10, R11, R16, R17, R20, R25, R30, R31, R32, R36, R37, R90, R91 and R92.</i> <i>Can also be used with R12, R13, R18, R19, R22 and R33 but only in conditions below 200°C</i>
1.5mm	R4115
2.5mm	R4125
4.5mm	R4145

## Cable and Wire Insert

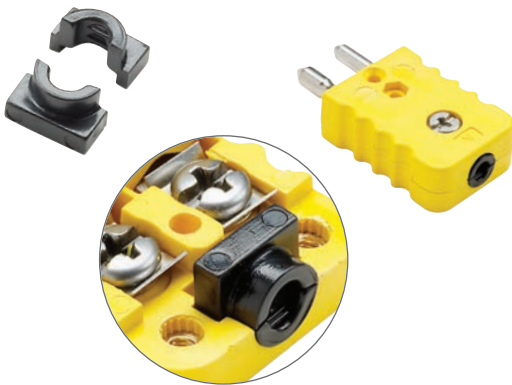

### Application

Fitted inside the connector, the insert allows the user to hold wires and cables in place, providing a strong grip without the insert protruding outside of the connector.

### Construction

Polypropylene for either round or oval cables.

**Temperature Rating**  
110°C.

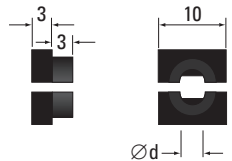

Approximate wire diameter 'd'	Round or Oval	Part codes for use with connectors: <i>R10, R11, R12, R16, R17, R20, R25, R30, R31, R32, R33, R36 and R37 in applications up to 160°C</i>
3.5mm	Round	R5035
2.0 x 1.5mm	Oval	R502015

## Cable Bending Protection



### Application

Provides bending protection for small wires and cables when used with standard connectors. Reduces potential mechanical damage to the cable. The conical end can be cut back to suit the cable.

### Construction

Silicone Rubber tapered insert.

**Temperature Rating**  
200°C.

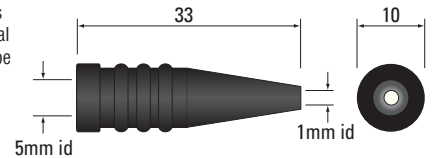

Part code for use with connectors: <i>R10, R11, R16, R17, R20, R25, R30, R31, R32, R36, R37, R90, R91 and R92.</i> <i>Can also be used with R12, R13, R18, R19, R22 and R33 but only in conditions below 200°C</i>
R43

## Cable Clamp

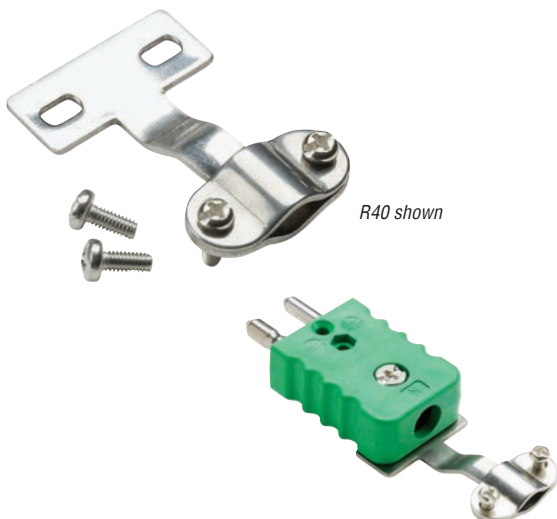

### Application

Allows the user to clamp wires and cables in place.

### Construction

Stainless steel including stainless steel screws.

### Temperature Rating

800°C (only limited by the temperature rating of the cable or connector it is attached to).

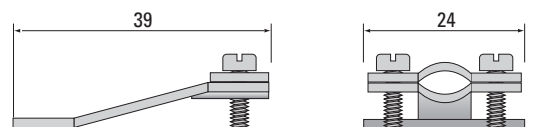

R40 shown

Part code for use with most 220°C & 350°C rated standard connectors <i>(R10, R11, R12, R13, R16, R17, R18, R19, R20, R22, R25, R30, R31, R32, R33, R36 and R37)</i>	Part code for use with duplex 220°C rated standard connectors <i>(R90, R91 and R92)</i>	Part code for use with 650°C rated ceramic connectors: <i>(R100, R120 and R200)</i>
R40	R46	R45

All dimensions are in mm

# Accessories for Standard Connectors

## Internal Crimp/Braze Adaptor



### Application

This adaptor can be crimped onto a mineral insulated cable or metal tube so it may then be attached to a standard connector. A crimp tool is available - see page 30.

Stainless steel adaptors may also be brazed. Brass adaptors can also be used to crimp some soft materials such as PVC or PFA wires and cables.

### Construction

For 220°C and 350°C range connectors: Nickel Plated Brass, Brass or Stainless Steel.

For Ceramic connectors: Stainless Steel only.

### Notes

Bore diameters listed are supplied at 'd' +0.1mm.

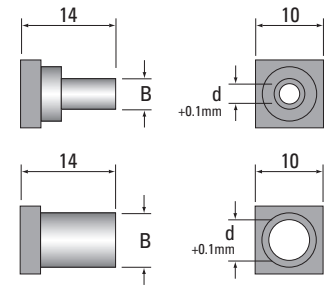

to suit tube diameter 'd'	Crimp diameter 'B'	Part codes for use with 220°C and 350°C rated connectors: R10, R11, R12, R13, R16, R17, R18, R19, R20, R22, R25, R30, R31, R32, R33, R36, R37, R90, R91 and R92			Part codes for use with 650°C rated connectors: R100, R120 and R200
		Nickel Plated Brass	Plain Brass	Stainless Steel*	Stainless Steel*
0.5mm	2.4mm	R8905	R8905B	R8805	R8005
0.8mm	2.4mm	-	R8908B	-	-
1.0mm	2.4mm	R8910	R8910B	R8810	R8010
1.5mm	3.2mm	R8915	R8915B	R8815	R8015
1.6mm (1/16")	3.2mm	R8916	R8916B	R8816	R8016
2.0mm	3.2mm	R8920	R8920B	R8820	R8020
2.3mm	3.2mm	R8923	-	-	-
3.0mm	4.4mm	R8930	R8930B	R8830	R8030
3.2mm (1/8")	4.4mm	R8932	R8932B	R8832	R8032
4.0mm	6.0mm	R8940	-	-	-
4.5mm	6.0mm	R8945	R8945B	R8845	R8045
4.8mm (3/16")	6.0mm	R8948	R8948B	R8848	R8048
5.5mm	6.5mm	R8955	-	-	-
6.0mm	8.0mm	R8960	R8960B	R8860	R8060
6.4mm (1/4")	8.0mm	R8964	R8964B	R8864	R8064

\* Stainless steel versions are recommended for users wishing to braze a tube to an adaptor, although they can be crimped in place with a suitable crimp tool - see page 30

## Internal Compression Tube Adaptor



### Application

This adaptor compresses onto a mineral insulated cable or metal tube so it may then be attached to a standard connector.

### Construction

All Stainless Steel parts.

### Notes

Bore diameters listed are supplied at 'd' +0.1mm.

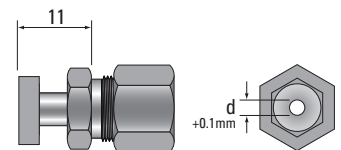

To suit tube diameter 'd'	Part codes for use with 220°C, 350°C and 650°C connectors: R10, R11, R12, R13, R16, R17, R18, R19, R20, R22, R25, R30, R31, R32, R33, R36, R37, R90, R91, R92, R100, R120 and R200
1.5mm	R7115
1.6mm (1/16")	R7116
2.0mm	R7120
3.0mm	R7130
3.2mm (1/8")	R7132
4.5mm	R7145
4.8mm (3/16")	R7148
6.0mm	R7160
6.4mm (1/4")	R7164

All dimensions are in mm

# Accessories for Standard Connectors

## External 'L' Bracket Crimp/Braze Adaptor



### Application

This bracket adaptor crimps or brazes onto a mineral insulated cable or metal tube so it may then be attached to a standard connector. Provides a stronger solution than the Internal Crimp/Braze Adaptor.

**Construction**  
Stainless Steel.

### Notes

Bore diameters listed are supplied at 'd' +0.1mm.

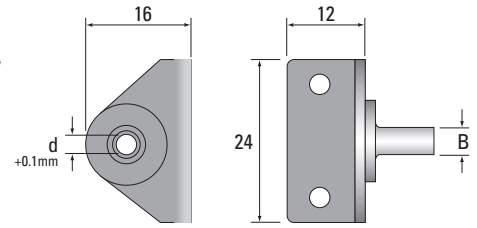

to suit tube diameter 'd'	Crimp diameter 'B'	Part codes for use with 220°C and 350°C rated connectors: <i>R10, R11, R12, R13, R16, R17, R18, R19, R20, R22, R25, R30, R31, R32, R33, R36 and R37</i>
1.5mm	2.4mm	<b>R8515</b>
1.6mm (1/16")	2.4mm	<b>R8516</b>
3.0mm	4.4mm	<b>R8530</b>
3.2mm (1/8")	4.4mm	<b>R8532</b>
4.5mm	6.0mm	<b>R8545</b>
4.8mm (3/16")	6.0mm	<b>R8548</b>
6.0mm	8.0mm	<b>R8560</b>
6.4mm	8.0mm	<b>R8564</b>

## External Compression Tube Adaptor



### Application

This adaptor compresses onto a mineral insulated cable or metal tube so it may then be attached to a standard connector. Provides a stronger solution than the Internal Compression Tube Adaptor.

### Construction

All Stainless Steel parts with Brass olive.

### Notes

Bore diameters listed are supplied at 'd' +0.1mm.

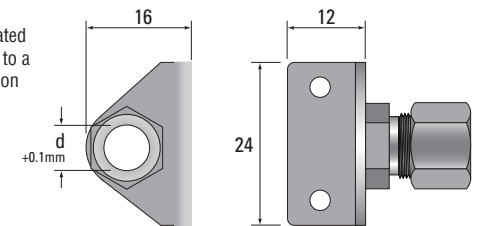

To suit tube diameter 'd'	Part codes for use with 220°C and 350°C rated connectors, <i>R51XX series can be used with connectors: R10, R11, R12, R13, R16, R17, R18, R19, R20, R22, R25, R30, R31, R32, R33, R36, R37, R90, R91 and R92.</i> <i>R52XX series can be used with connectors: R100, R120 and R200</i>	
	For use with 220°C and 350°C connectors	For use with 650°C ceramic connectors
1.5mm	<b>R5115</b>	<b>R5215</b>
1.6mm (1/16")	<b>R5116</b>	<b>R5216</b>
2.0mm	<b>R5120</b>	<b>R5220</b>
3.0mm	<b>R5130</b>	<b>R5230</b>
3.2mm (1/8")	<b>R5132</b>	<b>R5232</b>
4.5mm	<b>R5145</b>	<b>R5245</b>
4.8mm (3/16")	<b>R5148</b>	<b>R5248</b>
6.0mm	<b>R5160</b>	<b>R5260</b>
6.4mm (1/4")	<b>R5164</b>	<b>R5264</b>
8.0mm	<b>R5180</b>	<b>R5280</b>

All dimensions are in mm

# Accessories for Standard Connectors

## 'U' Bracket Cable & Wire Clamp



R47 shown

### Application

Allows the user to attach a pair of standard connectors together and use as a cable and wire clamp.

### Construction

Stainless steel including stainless steel screws.

Part codes for use with a pair of:		
220°C and 350°C rated two pin connectors R10, R11, R12, R13, R20, R22, R30, R32, R36 or R37	220°C and 350°C rated three pin connectors R16, R17, R18, R19, R25, R31 or R33	650°C rated ceramic connectors R100, R120 or R200
R47	R48	R49

### R47

for use with a pair of two pin connectors

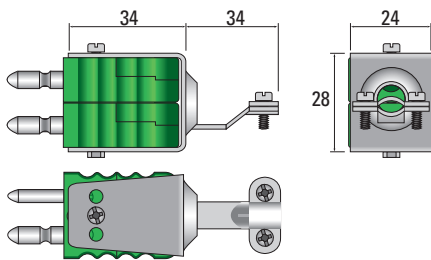

### R48

for use with a pair of three pin connectors

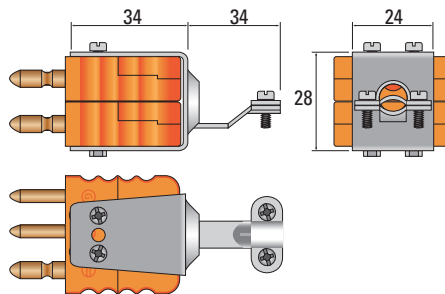

### R49

for use with a pair of ceramic two pin connectors

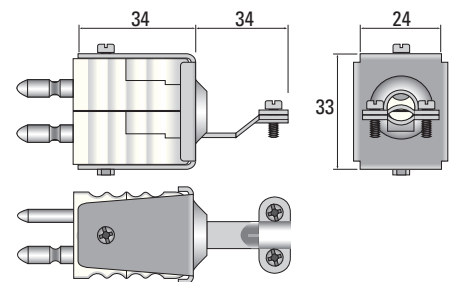

## 'U' Bracket Crimp Adaptor



R9460 shown.

### Application

This adaptor crimps onto a mineral insulated cable or metal tube so it may then be attached to a pair of standard connectors. A crimp tool is also available for 8.0mm crimp diameter - see page 30.

### Construction

Stainless Steel.

### Notes

Bore diameters listed are supplied at 'd' +0.1mm.

to suit tube diameter 'd'	Crimp diameter 'B'	Part codes for use with a pair of:		
		220°C and 350°C rated two pin connectors R10, R11, R12, R13, R20, R22, R30, R32, R36 or R37	220°C and 350°C rated three pin connectors R16, R17, R18, R19, R25, R31 or R33	650°C rated ceramic connectors R100, R120 or R200
6.0mm	8.0mm	R9460	R9560	R9660
6.4mm (1/4")	8.0mm	R9464	R9564	R9664
8.0mm	10.0mm	R9480	R9580	R9680

### R94XX

for use with a pair of two pin connectors

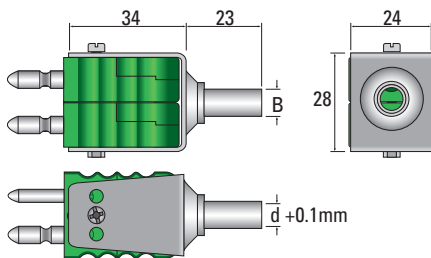

### R95XX

for use with a pair of three pin connectors

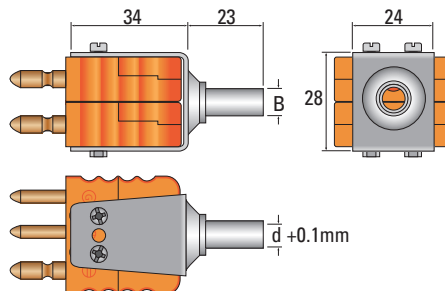

### R96XX

for use with a pair of ceramic two pin connectors

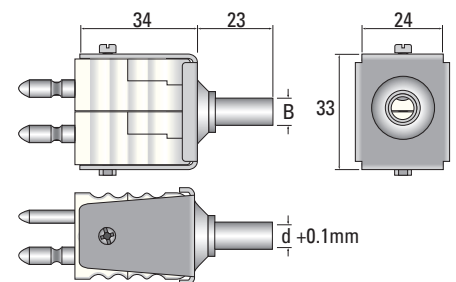

All dimensions are in mm

# Accessories for Standard Connectors

## 'U' Bracket Compression Tube Adaptor

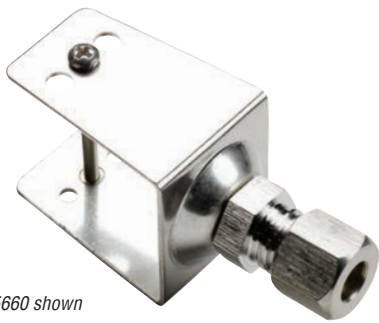

R5660 shown

### Application

This adaptor compresses onto a mineral insulated cable or metal tube so it may then be attached to a pair of standard connectors.

### Construction

Stainless Steel with Brass olive.

### Notes

Bore diameters listed are supplied at 'd' +0.1mm.

to suit tube diameter 'd'	Part codes for use with a pair of:		
	220°C and 350°C rated two pin connectors R10, R11, R12, R13, R20, R22, R30, R32, R36 or R37	220°C and 350°C rated three pin connectors R16, R17, R18, R19, R25, R31 or R33	650°C rated ceramic connectors R100, R120 or R200
1.5mm	R5615	R5715	R5815
1.6mm (1/16")	R5616	R5716	R5816
3.0mm	R5630	R5730	R5830
3.2mm (1/8")	R5632	R5732	R5832
4.5mm	R5645	R5745	R5845
4.8mm (3/16")	R5648	R5748	R5848
6.0mm	R5660	R5760	R5860
6.4mm (1/4")	R5664	R5764	R5864
8.0mm	R5680	R5780	R5880

### R56XX

for use with a pair of two pin connectors

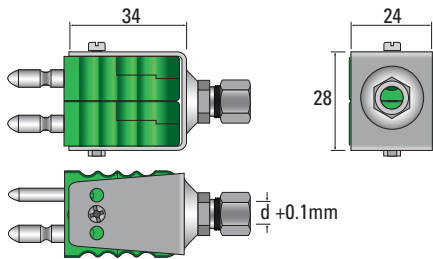

### R57XX

for use with a pair of three pin connectors

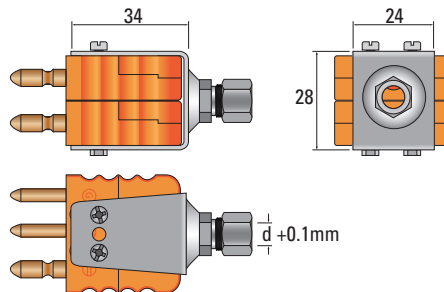

### R58XX

for use with a pair of ceramic two pin connectors

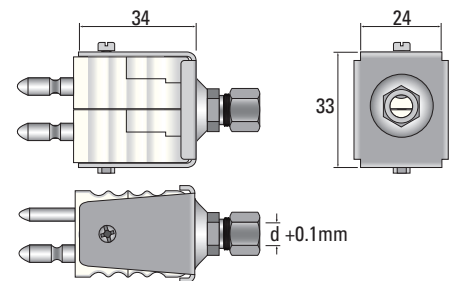

## Panel Bracket Adaptor

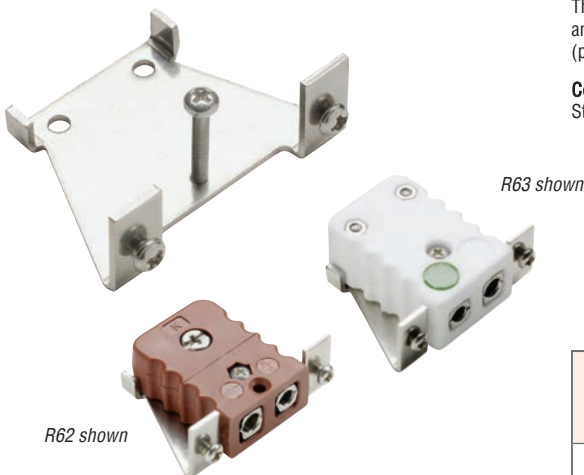

R62 shown

R63 shown

### Application

This adaptor allows the user to use a normal socket and adapt it to fit into RSC Series panels for R62 (page 31) or RCC Series panels for R63 (page 32).

### Construction

Stainless Steel bracket and screws.

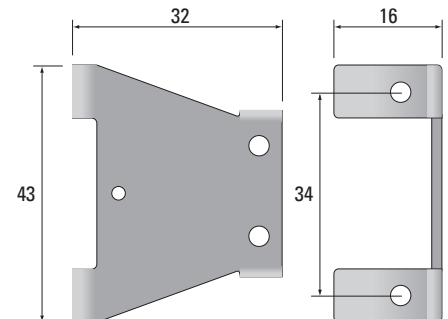

Part code for use with connectors: R20 and R22	Part code for use with ceramic connectors: R200 and R240
R62	R63

## Plastic Locking Clip

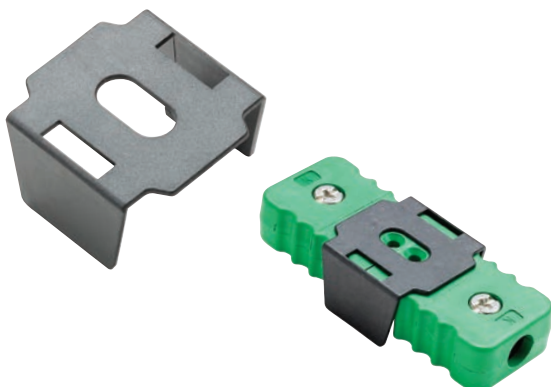

### Application

For extra protection to prevent accidental disconnection of a standard plug and socket. Can be easily placed over a closed pair of connectors by hand (does not require special tools).

### Construction

ABS.

### Temperature Rating

110°C.

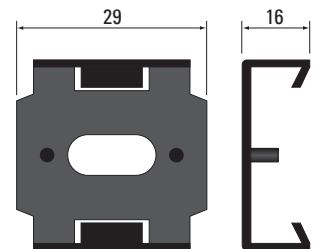

Part code for use with connectors: R10 and R20 or R11 and R20
R69

All dimensions are in mm

# Accessories for Standard Connectors

## Wire Locking Clip



### Application

These wire clips are used to prevent accidental disconnection of a standard plug and socket. Can be easily placed over a closed pair of connectors by hand (does not require special tools).

**Construction:** Stainless Steel Wire.

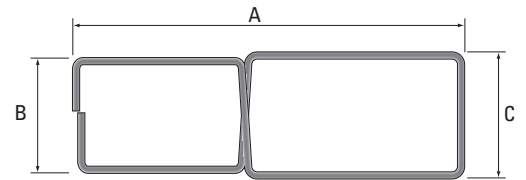

Part codes for use with a pair of:	
<b>220°C and 350°C rated two pin connectors</b> <b>R11 / R10 and R20, R13 / R12 and R22</b> (A=45mm, B=15mm, C=17mm)	<b>650°C rated ceramic connectors</b> <b>R100 / R120 and R200</b> (A=50mm, B=18mm, C=20mm)
<b>R66</b>	<b>R65</b>

## Protection Boots



R68 shown with connector in position

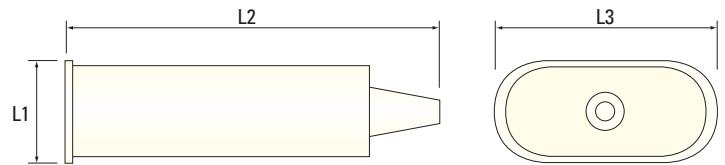

R68 shown

### Application

When using two of these protection boots, the user can prevent moisture or dirt from entering a connected pair of connectors. One boot is required per connector.

**Construction:** Silicone Rubber. **Temperature Rating:** 170°C.

Part code for use with <b>two pin</b> connectors: <b>R10 and R20 or R11 and R20</b> (L1=15mm, L2=55mm, L3=33mm)	Part code for use with <b>three pin</b> connectors: <b>R16 and R25</b> (L1=15mm, L2=55mm, L3=46mm)
<b>R68</b>	<b>R67</b>

## Panel Punch



Assembled

### Application

This simple device can be used to punch a hole in aluminium, mild steel and some plastics up to 3.5mm thick in order to mount R26, R26H and R32 connectors.

Part code for use with connectors: <b>R26 and R26H - 27mm diameter cutout</b>	Part code for use with connector <b>R32 only - 28.3mm diameter cutout</b>
<b>R98</b>	<b>R99</b>

# Crimp Tool

## Crimp Tool for use with Miniature and Standard Crimp Adaptors



Die Sets supplied separately

### Application

The HCT crimp tool can be used with most of our crimpable tube adaptors (except 10.0mm crimp diameter). Crimp diameters can be found on the relevant accessory page.

Part codes suitable for use with crimp adaptors: F80**, F87**, F89**, F89**B, R80**, R85 **, R89**, R89**B, R94 **, R95** and R96**	
<b>Crimp Tool</b>	<b>HCT</b>
<b>Die Set 1 – Crimp Diameters: 2.4, 3.2 &amp; 4.4mm*</b>	<b>HCDIE1</b>
<b>Die Set 2 – Crimp Diameters: 6.0, 6.5 &amp; 8.0mm*</b>	<b>HCDIE2</b>

Note: \* These are crimp diameters, not tube diameters

# Standard Connector Panels

## Anodised Aluminium and Stainless Steel Panels - For Flanged 2 Pin Standard Connectors

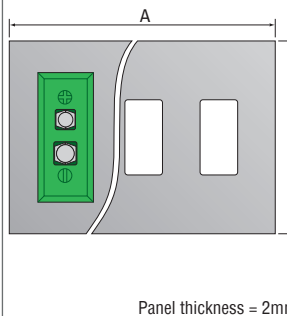
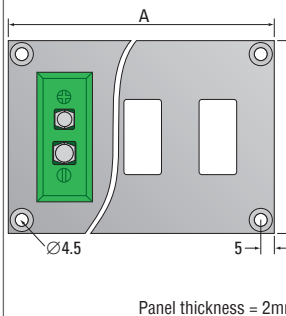
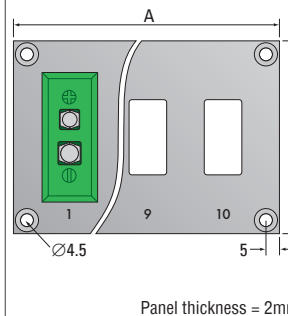
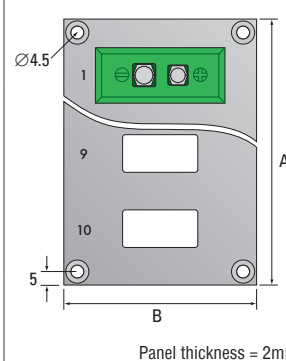
For use with connectors <b>R29</b> , <b>R29S</b> and <b>R34*</b>		<b>RFP / RSP</b> Panel without panel mounting holes		<b>RFS / RSS</b> Panel with panel mounting holes		<b>RFH</b> Horizontal, numbered panel with panel mounting holes	<b>RFV</b> Vertical, numbered panel with panel mounting holes
							
No. of Channels	Dimensions A x B in mm	<b>RFP</b> Aluminium Panel	<b>RSP</b> Stainless Steel Panel	<b>RFS</b> Aluminium Panel	<b>RSS</b> Stainless Steel Panel	<b>RFH</b> Aluminium Panel	<b>RFV</b> Aluminium Panel
1	37 x 67	<b>RFP01</b>	<b>RSP01</b>	<b>RFS01</b>	<b>RSS01</b>	<b>RFH01</b>	<b>RFV01</b>
2	62 x 67	<b>RFP02</b>	<b>RSP02</b>	<b>RFS02</b>	<b>RSS02</b>	<b>RFH02</b>	<b>RFV02</b>
4	112 x 67	<b>RFP04</b>	<b>RSP04</b>	<b>RFS04</b>	<b>RSS04</b>	<b>RFH04</b>	<b>RFV04</b>
6	162 x 67	<b>RFP06</b>	<b>RSP06</b>	<b>RFS06</b>	<b>RSS06</b>	<b>RFH06</b>	<b>RFV06</b>
8	212 x 67	<b>RFP08</b>	<b>RSP08</b>	<b>RFS08</b>	<b>RSS08</b>	<b>RFH08</b>	<b>RFV08</b>
10	262 x 67	<b>RFP10</b>	<b>RSP10</b>	<b>RFS10</b>	<b>RSS10</b>	<b>RFH10</b>	<b>RFV10</b>
12	312 x 67	<b>RFP12</b>	<b>RSP12</b>	<b>RFS12</b>	<b>RSS12</b>	<b>RFH12</b>	<b>RFV12</b>
16	212 x 113.5	<b>RFP16</b>	–	<b>RFS16</b>	–	<b>RFH16</b>	<b>RFV16</b>
20	262 x 113.5	<b>RFP20</b>	–	<b>RFS20</b>	–	<b>RFH20</b>	<b>RFV20</b>
24	312 x 113.5	<b>RFP24</b>	–	<b>RFS24</b>	–	<b>RFH24</b>	<b>RFV24</b>

These panels are suitable for use with the following connectors, which should be ordered separately:

**R29** - Standard Flanged Panel Socket with Bracket, **R29S** - Standard Flanged Panel Socket with Spring Clip, **R34** - Standard High Temp Flanged Panel Socket with Bracket\*

\*Note: Aluminium Panels are rated to 250°C which is lower than the rating of the connectors marked with an asterisk (R34).

## Anodised Aluminium and Stainless Steel Panels - For use with Lugged 2 Pin Standard Connectors

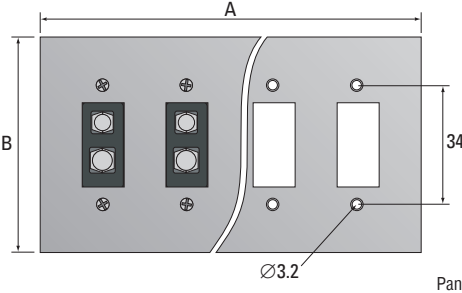
For use with connectors <b>R27</b> , <b>R30</b> , <b>R36</b> , <b>R37</b> and <b>R22</b>		<b>RCP / RSC</b> Panel without panel mounting holes			
					
No. of Channels	Dimensions A x B in mm	<b>RCP</b> Aluminium Panel	<b>RSC</b> Stainless Steel Panel		
1	37 x 67	<b>RCP01</b>	<b>RSC01</b>		
2	62 x 67	<b>RCP02</b>	<b>RSC02</b>		
4	112 x 67	<b>RCP04</b>	<b>RSC04</b>		
6	162 x 67	<b>RCP06</b>	<b>RSC06</b>		
8	212 x 67	<b>RCP08</b>	<b>RSC08</b>		
10	262 x 67	<b>RCP10</b>	<b>RSC10</b>		
12	312 x 67	<b>RCP12</b>	<b>RSC12</b>		

These panels are suitable for use with the following connectors, which should be ordered separately:

**R27** - Standard Lugged Open Back Panel Socket, **R30** - Standard Lugged Closed Back Panel Socket,

**R37** - Standard Lugged Closed Back Panel Plug and **R22** - Standard High Temp Socket with **R62** Adaptor\*

These panels are supplied with the correct screws and nuts to allow termination of lugged connectors into the panel slots.

\*Note: Aluminium Panels are rated to 250°C which is lower than the rating of the connectors marked with an asterisk (R22).

All dimensions are in mm

# Standard Connector Panels

## Anodised Aluminium Panel with Mounting Kit - For use with R28 Connectors

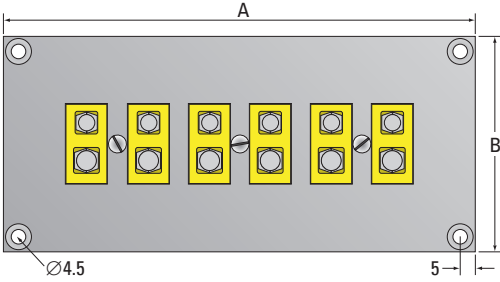
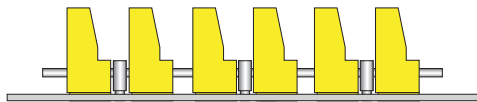
For use with connector <b>R28</b>		<b>RWS</b> Panel with panel mounting holes	
 <b>R28</b>			
		<p>Note: Connectors should be ordered separately. The RWS06 panel is compatible with the 6 way plug RPP* - *</p> <p style="text-align: right;">Panel thickness = 2mm</p>	
No. of Channels	Dimensions A x B in mm	<b>RWS Aluminium Panel</b> The six way panel is supplied complete with a mounting kit	<b>Additional Mounting Kit for 6-way Panel</b> Kit comprises of a set of fixing adaptors, bar and screws
<b>6</b>	<b>146 x 67</b>	<b>RWS06</b>	<b>RMK06</b>

## Anodised Aluminium and Stainless Steel Panels - For use with 3 Pin Standard Panel Connectors

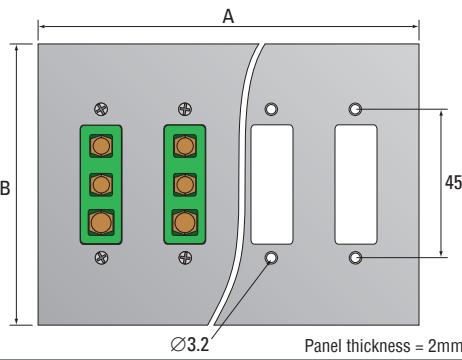
For use with connector <b>R31</b>		<b>RCT / RST</b> Panel without panel mounting holes	
 <b>R31</b>			
No. of Channels	Dimensions A x B in mm	<b>RCT Aluminium Panel</b>	<b>RST Stainless Steel Panel</b>
<b>2</b>	<b>61 x 87</b>	<b>RCT02</b>	<b>RST02</b>
<b>4</b>	<b>110 x 87</b>	<b>RCT04</b>	<b>RST04</b>
<b>6</b>	<b>159 x 87</b>	<b>RCT06</b>	<b>RST06</b>
<b>12</b>	<b>306 x 87</b>	<b>RCT12</b>	<b>RST12</b>

These panels are suitable for use with the **R31** - Standard Three Pin Lugged Panel Socket, which should be ordered separately. These panels are supplied with the correct screws and nuts to allow termination of lugged connectors into the panel slots.

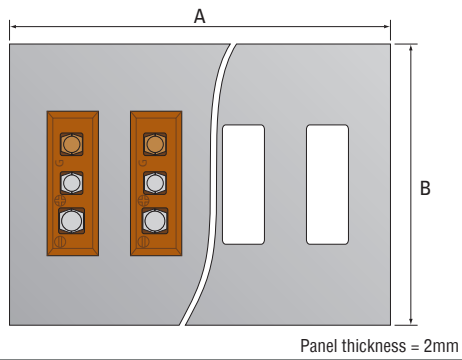
For use with connector <b>R35</b>		<b>RFT / RSF</b> Panel without panel mounting holes	
 <b>R35*</b>			
No. of Channels	Dimensions A x B in mm	<b>RFT Aluminium Panel</b>	<b>RSF Stainless Steel Panel</b>
<b>2</b>	<b>62 x 67</b>	<b>RFT02</b>	<b>RSF02</b>
<b>4</b>	<b>112 x 67</b>	<b>RFT04</b>	<b>RSF04</b>
<b>6</b>	<b>162 x 67</b>	<b>RFT06</b>	<b>RSF06</b>

These panels are suitable for use with the following connectors, which should be ordered separately: **R35** - Standard High Temp Three Pin Flanged Panel Socket\*  
\*Note: Aluminium Panels are rated to 250°C which is lower than the rating of the connectors marked with an asterisk (R35).

## Stainless Steel Panels - For use with Standard Ceramic Connectors

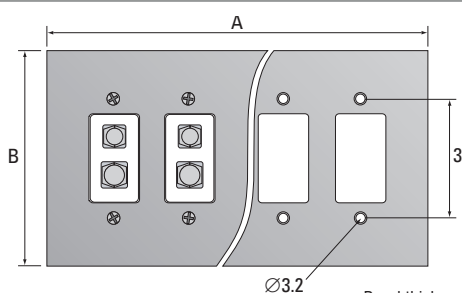
For use with connector <b>R200</b>		<b>RCC</b> Panel without panel mounting holes		No. of Channels	Dimensions A x B in mm	<b>RCC Stainless Steel Panel</b>
 <b>R200 (with R63 adaptor)</b>				<b>2</b>	<b>63 x 67</b>	<b>RCC02</b>
				<b>4</b>	<b>111 x 67</b>	<b>RCC04</b>
				<b>6</b>	<b>159 x 67</b>	<b>RCC06</b>
				<b>12</b>	<b>303 x 67</b>	<b>RCC12</b>

These panels are suitable for use with the following connectors, which should be ordered separately:  
**R200** - Standard Ceramic Socket with **R63** Adaptor. These panels are supplied with the correct screws and nuts to allow termination of lugged connectors into the panel slots.  
All dimensions are in mm





# Notes

---

# Terms and Conditions

---

## Prices

Prices for all products are provided in the TC price list. Should there be any price amendments then a new price list will be issued accordingly. If you receive an invoice where there is a price query then please advise us of this discrepancy within 7 days of the invoice date. Every effort will be made to resolve the query amicably.

## Descriptions

We give as much detail as is possible on all products and further details can be obtained from us promptly where necessary. Whilst we do not accept any liability for errors or omissions, our copywriters have done a good job to check this catalogue carefully. If there are any problems though, we will try our hardest to sort them out between us. We want you to come back.

## Suitability

The suitability of any of the products shown in this catalogue is entirely at your discretion, as the purchaser must be the best judge for any particular application. However, in the unlikely event of there being a problem, we will try our hardest to find a speedy resolution to the benefit of all concerned. We want your continuing business!

## Liability and guarantee

All of our products are guaranteed to be free from defect or faulty workmanship. We will promptly replace, at our cost any product which we consider as faulty and our limitation of liability is limited to the value of the product in question.

## Product improvement

Product improvement is a continuing goal at TC. We reserve the right to change, vary or alter the product specification without prior notification.

## Damage in transit or shortages

All our products are checked and packed with care, but if you do have a problem, call us as soon as you know, but no later than seven days following receipt of goods. We will look to resolve the problem to everyone's satisfaction.

## Ownership

Goods remain our property until they are paid for in full.

## Copyright

Reproduction in part or whole of this catalogue without written prior consent is prohibited.

## Promise

We promise to give you the best possible service. If you think that you have not been dealt with to your satisfaction, speak to our Customer Services Manager who will do all that is possible to rectify the matter.





**PO Box 130**

**Uxbridge**

**UB8 2YS**

**United Kingdom**

**Tel: 01895 252222**

**International: +44 1895 252222**

**Email: [info@tc.co.uk](mailto:info@tc.co.uk)**

**Web: [www.tc.co.uk](http://www.tc.co.uk)**

© TC Ltd.

Issue Number: 0324

**TC Ltd for Temperature Sensing, Measurement and Control**